



The tyre

Mechanical and acoustic comfort





The tyre

Mechanical
and acoustic comfort

**Publisher: Société de Technologie Michelin
23, rue Breschet, 63000 Clermont-Ferrand**

© Société de Technologie Michelin, 2002

Layout: Japa - Photos: Michelin picture bank, Japa picture bank
Translated by Coup de Puce Expansion
Made in France

Reproduction, representation, adaptation or translation of any part of this work without the permission of the copyright owner is unlawful.

**Requests for permission or further information should be sent to:
Manufacture Française des Pneumatiques Michelin
Service Groupe Communication/Technique
Place des Carmes Déchaux, 63040 Clermont-Ferrand Cedex 09
FRANCE**

Mechanical and acoustic comfort

7 Introduction



9 I Vibrations

12 I.1 WHAT IS A VIBRATION?

13 I.2 WHAT IS NOISE?

- 13 ■ What is sound?
- 14 ■ Sound pressure
- 14 ■ The decibel
- 14 ■ The acoustic intensity level
 - 15 *A little more information on...* acoustic intensity
 - 15 *A little more information on...* acoustic intensity level
 - 15 *A little more information on...* sound pressure level
- 15 ■ Intensity level decreases as distance increases
 - 16 *A little more information on...* the effect of distance on acoustic intensity

17 I.3 CHARACTERISTICS OF A VIBRATION, UNITS AND NOTATION

- 17 ■ Amplitude
 - 17 *A little more information on...* the expression of acceleration levels in dB
- 18 ■ Period and frequency
- 18 ■ Damping

19 I.4 SIMPLE VIBRATIONS AND COMPLEX VIBRATIONS

20 I.5 WHAT IS A NATURAL MODE?

- 22 ■ The natural modes of a taut string
 - 24 *A little more information on...* the natural modes of homogeneous, elastic materials
 - 25 *A little more information on...* the natural modes of a taut string
- 26 ● Boundary conditions
- 27 Vibrations : Don't forget the basics!



29 II Human perception

30 II.1 HUMAN SENSITIVITY TO VIBRATIONS

- 30 ■ Mechanical vibrations
- 30 ■ Acoustic vibrations

31 II.2 HOW FREQUENCY AFFECTS THE HUMAN PERCEPTION OF VIBRATIONS

32 II.3 HOW AMPLITUDE AFFECTS THE HUMAN PERCEPTION OF VIBRATIONS

- 32 ■ Acoustic vibrations
- 32 ■ Mechanical vibrations

33 II.4 HUMAN SENSITIVITY TO ACOUSTIC VIBRATIONS

- 33 ■ Human hearing range
- 33 ■ The decibel (A) or dB(A)
- 34 ■ Peaks

35 **II.5 HUMAN SENSITIVITY**

TO MECHANICAL VIBRATIONS

37 *A little more information on...* weightings and their application to automobile comfort

38 Human perception : Don't forget the basics!



39 **III The tyre: a vibration filter**

41 **III.1 THE TYRE: A DEFORMABLE SYSTEM**

- 41 ● Directional stiffness

42 **III.2 HOW THE TYRE CONTRIBUTES TO COMFORT**

44 **III.3 TYRE VIBRATION**

44 **III.3.1 Below 30 Hz: spring-type behaviour**

- 44 ■ Measuring the radial stiffness of a tyre rolling over an obstacle

45 **III.3.2 Between 30 and 250 Hz: a tyre's natural modes**

- 45 ■ Identifying a tyre's natural modes
- 46 ■ Radial modes
- 46 ■ Transversal modes
- 47 ■ Integer modes and semi-integer modes

50 **III.3.3 Above 250 hertz: vibrations in front of and behind the contact patch**

- 50 ■ Measuring tyre response

51 **III.4 PROPAGATION PATHS**

- 51 ■ Structure-borne propagation towards passengers
- 52 ■ Structure-borne propagation towards nearby people
- 52 ■ Airborne propagation towards passengers and nearby people
- 53 The tyre: a vibration filter : Don't forget the basics!



55 **IV Mechanisms leading to vibratory disturbance**

56 **IV.1 JOLTING ON BUMPY ROADS**

- 56 ■ Excitation frequencies
- 57 ■ Natural modes of vehicles with suspension
- 58 ● Pitching and bouncing
- 59 ■ Effect of tyres on vibration levels
- 60 *A little more information on...* the natural frequency of sprung and unsprung masses

61 **IV.2 IMPACTS DUE TO ISOLATED OBSTACLES**

- 61 ■ The mechanism
- 62 ■ The forced response
- 63 ● The tyre "absorbs" shocks
- 63 ■ Tyre response on the road
- 64 ■ Effect of tyres on vibration levels

65 **IV.3 THE NON-UNIFORMITIES OF TYRE/WHEEL ASSEMBLIES**

- 65 ■ Mass non-uniformities
- 66 ● Wheel balancing

67	■ Shape non-uniformities
68	■ Stiffness non-uniformities
69	■ Excitation frequencies
70	<i>A little more information on...</i> beating
71	■ The causes of non-uniformities
71	● The flat spot
72	<i>A little more information on...</i> match mounting
73	IV.4 THE MECHANICAL COMFORT OF VEHICLES WITHOUT SUSPENSION
73	■ Earthmovers
75	■ Farm and forestry vehicles
76	Mechanisms leading to vibratory disturbance : Don't forget the basics!
77	 V Mechanisms leading to acoustic disturbance
79	V.1 INTERIOR NOISE - EXTERIOR NOISE
80	V.2 EXCITATION BY THE ROAD SURFACE
80	V.2.1 Noise of impact against isolated obstacles
80	■ Potential reduction of impact noise perceived in the passenger cabin
80	V.2.2 Road noise
81	<i>A little more information on...</i> road surface roughness
82	■ Vibration of the tyre structure
83	■ Potential reduction of road noise perceived in the passenger cabin

83	<i>A little more information on...</i> road noise in the passenger cabin
84	■ Vibration of air inside the tyre
85	V.3 EXCITATION BY TREAD PATTERN
85	V.3.1 Impact of tread blocks on the road surface
85	<i>A little more information on...</i> vibrations affecting the tyre belt at the leading edge of the contact patch
86	■ Tread whine
88	● Tread pattern adjustment
89	■ Amplitude modulation or beating
90	■ Tread whine and beating: the art of arranging tread patterns
91	■ Acoustic level
93	V.3.2 Noise of rubber friction on the road surface
93	■ Sizzling
93	■ Squealing
95	V.3.3 Air pumping
95	V.3.4 Amplifying phenomena
95	■ The organ pipe
96	■ The horn effect
97	V.4 EFFECT OF TREAD PATTERN, WIDTH AND CONSTRUCTION ON THE LEVEL OF EXTERIOR NOISE
98	V.5 EFFECT OF ROAD SURFACE ON EXTERIOR NOISE
99	Mechanisms leading to acoustic disturbance : Don't forget the basics!

101

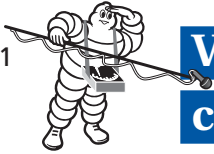

VI Testing mechanical and acoustic comfort

103

VI.1 TESTS ON ANALYTICAL MACHINES

- 103 ■ Impacts due to isolated obstacles (mechanical and acoustic comfort)
- 104 ■ Measuring a vehicle's transfer function
- 105 ■ Noise intensity measurements

106

VI.2 TRACK MEASUREMENTS USING TEST VEHICLES

- 106 ■ Simplified measurements of jolting on bumpy roads
A little more information on... calculating RMS and RSS indices
- 106 ■ Measuring noise inside the passenger cabin: road noise and tread pattern noise

108

VI.3 TEST DRIVER ASSESSMENT OF VIBRATION AND ACOUSTIC DISCOMFORT

- 109 ● Calibration of test driver perception

110

VI.4 REGULATIONS ON PERMISSIBLE SOUND LEVELS EMITTED BY MOTOR VEHICLES

- 110 ■ Drive-by tests: European directive 92/97
- 113 ■ Drive-by tests using soundproofed vehicles
- 115 ■ A project to combine drive-by and cruise-by tests
- 115 ■ Coast-by tests: new European directive 2001/43/CE
A little more information on... calculating tyre/road surface noise level with vehicle coasting
- 116 ■ *A little more information on... temperature corrections*

117



VII Virtual prototyping

121

Annex Uniformity verifications during manufacture

123

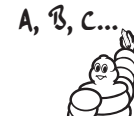

Index

128

Bibliography

Mechanical and acoustic comfort

If it never rained, road surfaces could be made to be perfectly smooth and tyres could be designed without tread patterns, meaning fewer vibrations and much less noise.

How does discomfort arise?

As things stand, tyres need to grip on wet road surfaces. They therefore need a tread pattern to disperse water and restore dry contact with the road surface, which is deliberately textured for the same purpose.

Roads also include obstacles such as bumps, manhole covers, surface joints or speed bumps. Furthermore, tyres are flexible objects which are never perfectly round and which need to be distorted to grip on road surfaces.

The combination of the tyre's distortion and road surface irregularities produces small shocks in the contact patch, which can make the tyre, the vehicle and the surrounding air vibrate, leading to mechanical and acoustic vibrations. When propagated to people inside or outside the vehicle, these vibrations can be most disturbing and also induce fatigue.

To improve comfort for car passengers, bystanders and local residents living alongside roads, tyres need to absorb surface irregularities while producing less noise. Increased comfort enhances driving pleasure and reduces driver fatigue, making driving safer.

Comfort is so firmly rooted in our daily lives that it may be hard to imagine how complex a concept it is. In reality, disciplines such as physics, physiology, psychoacoustics and modelling, to name but a few, are all brought into play when seeking to understand the causes of discomfort and subsequently to find

acceptable technical solutions by predicting what the human body will experience.

Road comfort involves three elements: the tyre, the road and the vehicle. It is a multidisciplinary subject in which tyre engineers, car manufacturers and road builders need to work closely together.

The tyre, a tremendous breakthrough

In the late XIXth century, automobile development was seriously hampered by comfort problems. The rigid wheels not only gave passengers a rough ride but the violent shocks they transmitted to the vehicle led to its "self-destruction" when driven over 30 km/h. The invention of the pneumatic tyre cleared the path for further developments.

In 1895, it was proven that tyres could absorb shocks. Three years later, the *Jamais Contente*—a car fitted with Michelin tyres—broke the 100 km/h barrier.

Manufacturers were fully aware that there was considerable room for progress. In 1920, large low-pressure tyres were developed. In 1930, the first patent on reducing tread pattern noise was issued. In 1946 came the invention of radial tyres with flexible side walls, whose ability to absorb shocks made driving even more comfortable.

Progress was not limited to tyres. An improved road infrastructure, quieter vehicles and increasingly efficient ways of filtering out vibrations also increased comfort.

While engineers have managed to decrease tyre noise, progress in other domains has led to a decrease in overall vehicle noise. Paradoxically, whenever the overall vibration level of the vehicle itself decreases, the

proportion of noise from tyre/road surface contact increases, unless tyre/road noise decreases to the same extent. This is why the tyre—which is a real source of comfort—is now being studied as a potential source of discomfort.

To limit vibrations, tyre engineers not only have to reduce them at the source, but also to minimise their transmission by ensuring optimal integration of each vehicle component. They therefore need to understand and control tyre/road surface/vehicle interactions.

This booklet reviews all the mechanisms involved in these interactions after two preliminary chapters on the basic principles governing vibrations and on human perception of vibrations (chapters I and II respectively).

Suggestion to readers:

If you fully grasp vibration mechanics, sound pressure, decibels and natural modes, go straight to chapter II. If you already know how human beings perceive vibrations, go straight to chapter III.



I *Vibrations*

Mechanical and acoustic comfort both involve vibration phenomena. To improve them, engineers study the structural and acoustic vibrations produced by shocks, friction and air compression when tyres are rolling over road surfaces.

To understand these complex vibrations, we first need to consider a few elementary vibratory systems.



The way people perceive vibrations depends on factors which can be divided into four main categories

The perception of a vibration depends primarily on two types of objective factors:

1 - factors related to the vibration itself:

- magnitude;
- frequency;
- damping.

Pleasure or discomfort?

We shall see that the perception of a vibration depends on its frequency and magnitude, which determine whether it is considered acceptable or uncomfortable.

2 - factors related to the propagation mode and the receiving sense organ:

- airborne or structure-borne propagation;
- perception by the ear, muscles or other organs;
- the direction of propagation.

Sound or vibration?

- if the vibration is transmitted by air and picked up by the eardrum, the person may perceive a sound;

- if the vibration is transmitted by a structure and picked up by another part of the body, the person's perception of its strength depends on which part of the body is affected (hands, for instance, react differently than feet).



Vibrations may be perceived very differently from one person to another and one situation to another, as human perception depends on:

3 - the characteristics of the person in question:

- age, sex, size, fitness;
- experience, individual or cultural habits;
- expectations, motivations.

4 - contextual factors:

- body position;
- activity at the time of vibration.

The perception of vibrations is thus partly subjective.

Nevertheless, we will not address these factors in great detail. The following sections mainly focus on an average car driver, passenger or local resident.



The subjective aspect of mechanical and acoustic comfort...



Cultural differences:

Automobile comfort is a very complex matter, as you will quickly see when comparing the criteria of different manufacturers. To satisfy the demands of their customers for both comfortable and enjoyable driving, French manufacturers design vehicles which generally combine a stiff suspension with soft, all-embracing seats.

In Germany, the opposite is often true: the suspension is softer and the seats firmer. French people often find German car seats too hard, because they are not used to them. However, over the years, many French people have grown accustomed to German cars and vice versa.

Contextual differences:

A car driver and passengers do not perceive the vibrations affecting them in the same way. A driver hardly ever experiences motion sickness, while passengers, who are on the very same road, are more likely to. Why?

It all depends on a combination of three perception systems: the body, the eyes and the brain, which anticipates sensations.

Passengers who read in a car are more likely to feel sick than passengers who do not. This is because what their bodies are feeling does not match what their eyes are seeing. However, even passengers watching the road are more likely to experience motion sickness than the driver. Drivers anticipate the vehicle's movements better because they know a few fractions of a second ahead of time that they are going to brake, accelerate or turn the steering wheel. Their brains are thus better able to predict movements than those of their passengers.



Different motivations:

All of us have at some time or another cringed at the noise from a moped whose owner has modified its exhaust pipe to increase speed and incidentally make more noise. Local residents suffer while the "offender" gets his kicks!



I.1

What is a vibration?

A vibration is defined as the alternating movement of a physical system around an equilibrium position.

The simplest case of a vibratory or oscillatory movement is that of a pendulum. When knocked, it swings in an alternating movement around its vertical position.

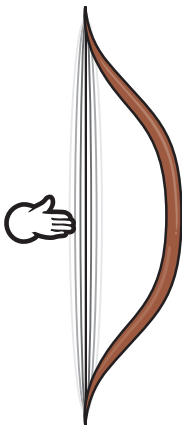
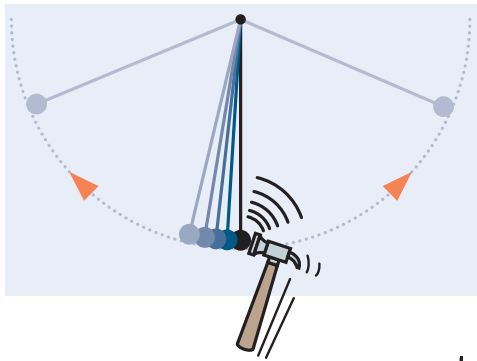

In an elastic medium such as water, air or a taut string, the vibration is revealed as a distortion.

The string of a bow vibrates in an arc shape after the archer has plucked it; the surface of water forms concentric ripples when a stone is thrown in. Likewise, a tyre may be distorted when subjected to a shock.



This distortion is due to the alternating motion of each point in the surrounding medium around its equilibrium position. When a point moves, it makes those around it move too: the movement is propagated from point-to-point at a constant speed, which itself depends on the physical medium and the temperature.



Note: in this illustration, the tyre vibratory distortion has been exaggerated. In actual fact it is seldom visible to the naked eye.

The propagation of a vibratory wave should not be confused with an actual displacement. The molecules of the vibrating body do not travel with the vibration wave, but oscillate around a fixed equilibrium position. This may be compared with a crowd rising to its feet at a sporting event, creating a ripple around the stadium.

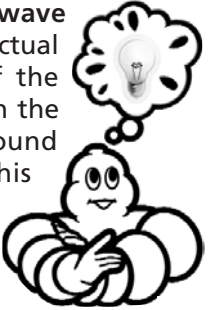

I.2

What is noise?



A **noise** is a sound which produces a disturbing or unpleasant auditory sensation.

■ WHAT IS SOUND?

Behind all auditory sensations, there is a vibrating body which becomes a **sound source**. Most often, this is a solid (violin string, loudspeaker diaphragm, etc.).

When a body is subjected to mechanical stress (a shock for instance), its different parts start vibrating. The surrounding air also starts to vibrate and forms pressure waves around the sound source which then reach the ear: this is **sound**. The notion of sound only has meaning if there is a receiving sense organ to pick it up, in this case, the ear.



The wave perceived by the ear corresponds to **pressure variations** in the surrounding air, referred to as sound pressure. Pressure variations are due to the alternating movement of the gas molecules around their equilibrium position (the molecules do not travel with the wave). The movements are very small (around one micron) but produce, in a domino effect, zones in which the air particles are compressed and others in which there are fewer air particles: this is a sound wave or acoustic wave.

Sound wave

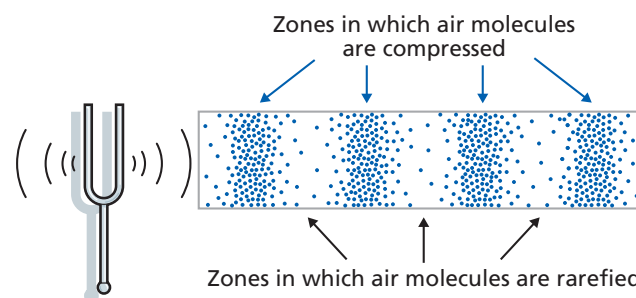

NB Liquids also transmit sound at speeds greater than that of air.

The speed of sound in air is 340 m/s (at 20°C).

The speed of sound in water is 1 425 m/s (at 20°C).

There is no propagation in a vacuum, so no sound is transmitted. The silence is absolute.

Acoustic disturbance: a very subjective notion!

Two people may perceive the same sound differently: the ticking of a clock may put some people to sleep but stop others from sleeping. The former will perceive "a pleasant sound", while the second will perceive a "very annoying noise"...

The same person hearing the same sound in two different situations may also perceive it differently. Disco music, which may be appreciated for dancing, might disturb the same person if he or she wanted to work or hold a serious conversation.

Another example: while the engines of some high-powered sports cars are perceived as noisy by some people, they sound like music to sports car fans.

■ SOUND PRESSURE

Sound pressure, or **acoustic pressure**, is the difference between the instantaneous air pressure in the presence of acoustic waves and atmospheric pressure (1 013 hectopascals, i.e. around 1 bar or 10^5 Pa).

This variation in pressure around atmospheric pressure is very slight. For a relatively intense sound, the pressure variation is approximately 0.1 Pa, i.e. 1 millionth of atmospheric pressure.

The human ear is sensitive to sound pressure ranging between the **threshold of hearing** P_0 ($2 \cdot 10^{-5}$ Pa) and the **threshold of pain** (20 Pa). The latter value is a million times bigger.

If we wanted to represent this pressure range linearly with a scale of 1 mm for 10^{-5} pascals, we would have to draw a line one kilometre long! However, the decibel* scale is a neat solution to this representation problem.

■ THE DECIBEL

The ear feels an increase in intensity when sound pressure increases from 1 to 2 pascals. It feels the same increase when the pressure increases from 2 to 4 pascals and then from 4 to 8, etc. This is **Fechner's law**: the ear's sensation is proportional to the logarithm of the excitation. This is why a logarithmic notation, the **decibel (dB)**, is used to characterise acoustic intensity.

*The bel is a unit of measurement created by American physicist Alexander Graham Bell (1847-1922). A decibel is one tenth of a bel.

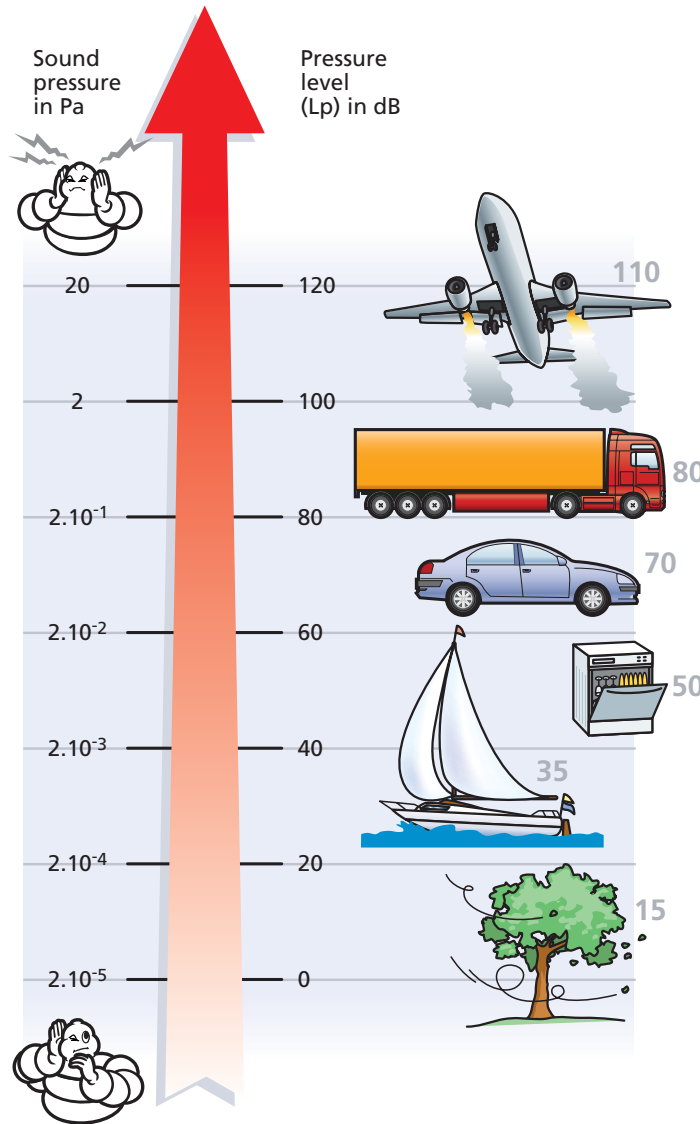

■ THE ACOUSTIC INTENSITY LEVEL

The **level*** of acoustic intensity, written L_I , expresses the ratio between the acoustic intensity (I) emitted by a sound source and the reference acoustic intensity (I_0), which corresponds to the human audibility threshold.

The **acoustic intensity level** is most often written in dB. It is then defined by:

$$L_I = 10 \cdot \log \frac{I}{I_0}$$

where I is the **acoustic intensity** in W/m^2 ,
and $I_0 = 10^{-12} W/m^2$

The decibel scale is not linear. Reducing the intensity level by 3 dB is the same as halving the intensity of the sound source.

	$I = 10^{-12} W/m^2$								$I = 1 W/m^2$						
I/I_0	1	2	4	8	16	32	64	...	10^{12}						
L_I in dB	0	3	6	9	12	15	18	...	120						

If two cars each emit 70 dB, for instance, the sum of the sound emitted by the two cars is not 140 dB but 73 dB.

*A level is defined as the ratio of one magnitude to a similar magnitude taken as a reference.

A little more information on...



... acoustic intensity

The acoustic intensity of a sound corresponds to the mechanical power developed by the movement of air molecules when stimulated by a source of vibration and received by a surface area of 1 m²:

$$I = \frac{P^2}{\rho c}$$

where: I is expressed in W/m²,

- P is the acoustic pressure, in pascals (Pa),
- ρ is the density of the propagation medium,
- c is the speed of propagation,
- and ρc, is the impedance of the propagation medium.

Comments: ρc is nearly constant.

In air, ρ ≈ 1.3 kg/m³ and c ≈ 340 m/s.

The equation is valid in a free field, in other words in a medium without obstacles such as walls, bumpy terrain or the like.

... acoustic intensity level

When the intensity (or power) of a sound source is doubled, the level of intensity increases by 3 dB.

$$10 \cdot \log\left(\frac{2I}{I_0}\right) = 10 \cdot \log 2 + 10 \cdot \log \frac{I}{I_0}$$

$$= 3 + 10 \cdot \log \frac{I}{I_0}$$

... sound pressure level

Given that: $I = \frac{P^2}{\rho c}$

Then: $\frac{I}{I_0} = \left(\frac{P}{P_0}\right)^2$ hence: $10 \cdot \log\left(\frac{I}{I_0}\right) = 20 \cdot \log \frac{P}{P_0}$

where: P₀ = 2x10⁻⁵ Pa, which corresponds to the human threshold of hearing.

The level of **sound pressure**, which is written L_p and is equal to acoustic intensity level L_I, is defined by:

$$L_p = 20 \cdot \log \frac{P}{P_0}$$

Consequently, when the sound pressure is doubled, the level of sound pressure increases by 6 dB.

$$20 \cdot \log\left(\frac{2P}{P_0}\right) = 20 \cdot \log 2 + 20 \cdot \log \frac{P}{P_0}$$

$$= 6 + 20 \cdot \log \frac{P}{P_0}$$

P/P ₀	1	2	4	8	16	32	64	...	10 ⁶
L _p in dB	0	6	12	18	24	30	36	...	120

■ INTENSITY LEVEL DECREASES AS DISTANCE INCREASES

The level of sound intensity perceived by the ear decreases rapidly as the distance between the person and the sound source increases. Whenever the distance is doubled, the level drops by 6 dB in the case of a point source (such as a single car) and by 3 dB in the case of a linear source (such as a line of moving cars).

Other factors can attenuate or amplify sound, such as the presence of absorbing or reflecting walls or the type of road surface.

A little more information on...



... the effect of distance on acoustic intensity

For a long vibratory source, the acoustic intensity perceived is inversely proportional to the perpendicular **distance** between the observer and the source.

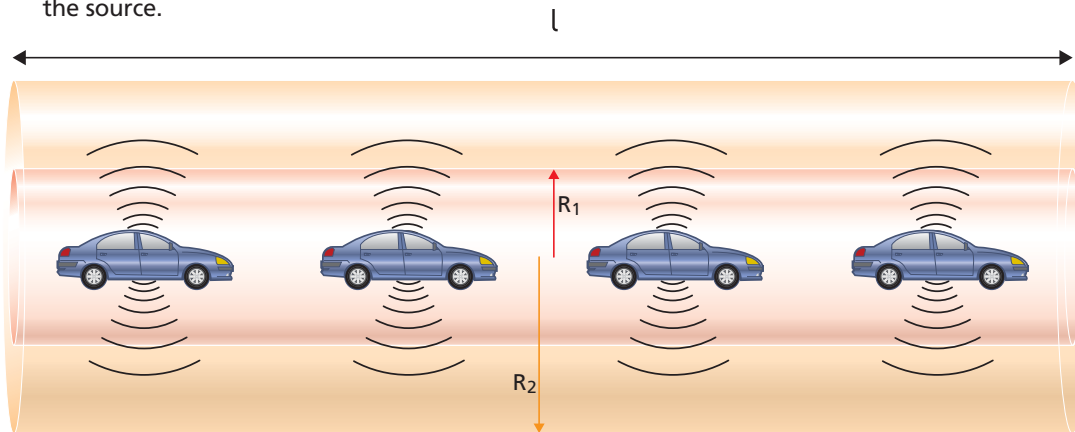

Quantified example for $l = 24 \text{ m}$

Power of source in W	0.08
R_1 in metres	2
R_2 in metres	4
Surface area of tube 1 in m^2	301
Surface area of tube 2 in m^2	603
Intensity received by tube 1 in W/m^2	2.7×10^{-4}
Intensity received by tube 2 in W/m^2	1.3×10^{-4}

i.e. 84 dB

i.e. 81 dB

For a linear sound source, the level of sound intensity perceived drops by **3 dB** whenever the distance is doubled. In this example, the level would only be 78 dB at 8 metres.

Reminders:

Surface area of the sphere: $S_s = 4\pi R^2$

Surface area of the tube: $S_t = 2\pi R \cdot l$

Intensity received: $I = \frac{W}{S}$

Level of intensity: $L_I = 10 \cdot \log\left(\frac{I}{I_0}\right)$

In the case of a point vibratory source, the acoustic intensity perceived by the ear is inversely proportional to the **square of the distance** between the observer and the source.

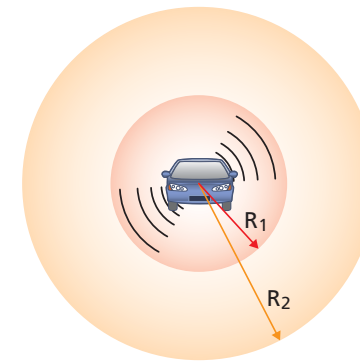

Quantified example:

Power of source in W	0.02
R_1 in metres	2
R_2 in metres	4
Surface area of sphere 1 in m^2	50.3
Surface area of sphere 2 in m^2	201.1
Intensity (I) received by sphere 1 in W/m^2	4×10^{-4}
Intensity (I) received by sphere 2 in W/m^2	1×10^{-4}

i.e. 86 dB

i.e. 80 dB

For a point source, the acoustic intensity level perceived drops by **6 dB** whenever the distance is doubled. In this example, the level would only be 74 dB at 8 metres.

I.3

Characteristics of a vibration, units and notation

A simple vibration is defined by:

- its amplitude;
- its period (or frequency);
- its damping.

It may be represented by a sinusoidal signal.

■ AMPLITUDE

The **amplitude A** (synonym magnitude) corresponds to the maximum level of a vibration. For a **mechanical vibration**, amplitude A may be displacement (in metres), velocity (in metres/second) or acceleration (in metres per square second).

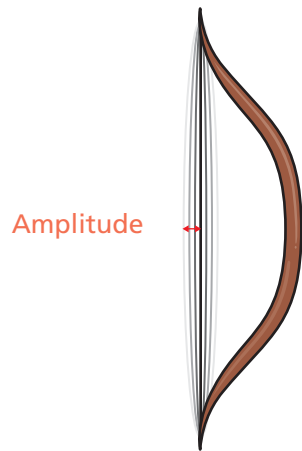

For an **acoustic vibration**, the vibration perceived corresponds to a variation in the surrounding pressure. The amplitude is then expressed in pascals (in other

A little more information on... 

... the expression of acceleration levels in dB

Like the acoustic intensity level, the amplitude of a mechanical vibration may be converted into a level of acceleration, written L_n and expressed in dB.

$$L_n = 20 \cdot \log\left(\frac{a}{a_0}\right)$$

where: a is the acceleration measured in m/s^2
 a_0 is the reference acceleration defined by the ISO 1683 standard, equal to 1 mm/s^2

NB When addressing the issue of automobile comfort, acceleration values (linear scale) are used more often than acceleration levels (logarithmic scale).

words, sound pressure) and may be converted into watts per square metre (acoustic intensity) or, as we have seen, into decibels (level of acoustic pressure or level of acoustic intensity).

Notations :

pascals: Pa

watts per square metre: W/m^2

decibels: dB

■ PERIOD AND FREQUENCY

The period of a vibrating body is the time it takes to make a complete cycle of displacement (of distortion) around its equilibrium position (positions ① to ⑤). It is written **T** and expressed in seconds.

Frequency *f* is equal to $1/T$ and is expressed in hertz (1 Hz = one cycle per second).

■ DAMPING

Damping is the relative and gradual decrease over time of the amplitude of an oscillation. It is written ***k(t)*** and expressed as a percentage of the amplitude per unit of time. For visco-elastic materials, such as elastomers, damping increases with frequency.

Complete cycle of a bowstring around its position of equilibrium

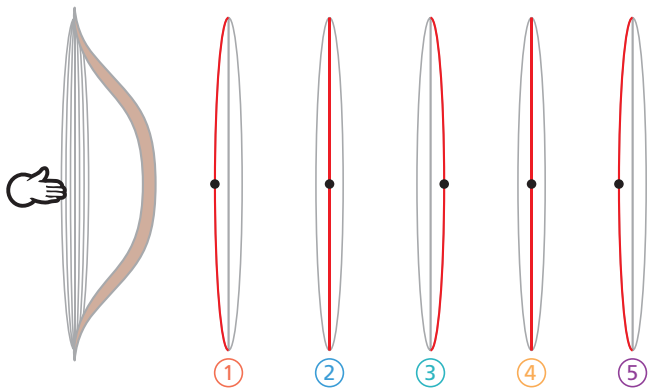

Positions ① to ⑤ constitute a complete cycle i.e. a period.

Let us look at the successive positions of a point on the bowstring. As soon as the string is released (figure ①), the point moves to the right. It goes through its equilibrium position (figure ②), continuing to move right. When it has reached its maximum distance to the right (figure ③), it returns to the left, goes through its equilibrium

Sinusoidal signal representing the successive positions of a point on the bowstring as a function of time

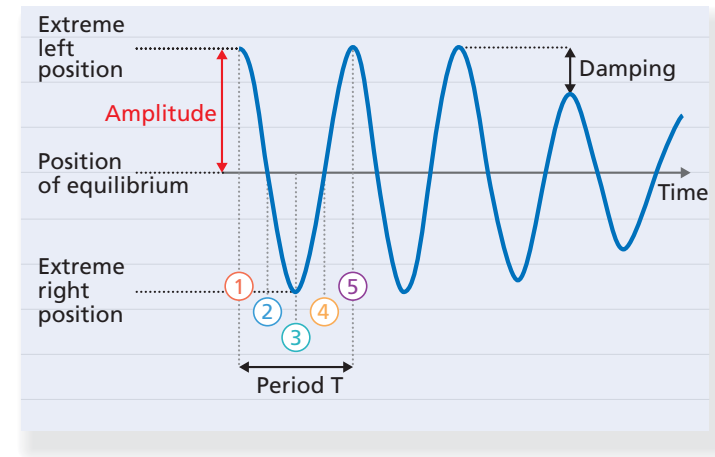

point again (figure ④) and starts to move away to reach its maximum displacement to the left (⑤), and so on until friction completely dampens the vibration. If we plot the successive positions of this string point as a function of time, we get the damped sinusoidal signal shown above.

I.4

Simple vibrations and complex vibrations

The sounds and vibrations to which we are subjected in everyday life hardly ever have a simple sinusoidal signal which would be easy to analyse. Sounds and vibrations are most often complex, in other words, made up of vibrations with different frequencies and amplitudes, which themselves vary over time. This is typically the case on a vehicle when the tyre/road surface contact causes multiple excitations (shocks, friction, etc.).

However, a complex periodic signal can always be broken down into a sum of elementary sinusoidal signals called **harmonics**.



By definition, the frequency of all the **harmonics** is a multiple of the first harmonic, which is known as the **fundamental**. The mathematical tool used for this analysis is the **Fourier decomposition**.

Let us consider a system with three different sound sources. A microphone recording gives us the complex temporal signal but does not allow us to identify the contribution made by each source (see opposite). On the other hand, the frequency spectrum obtained by breaking down the signal into a Fourier series enables us to identify the acoustic level of each source and to break down the complex signal into simple sinusoidal signals.

The damped non-periodic signals can also be broken down into a superposition of sines and cosines, using a more complex mathematical tool called the **Fourier transform** for which decomposition into a Fourier series is a specific case.

Breakdown of a complex signal into simple signals

Complex temporal signal obtained by recording

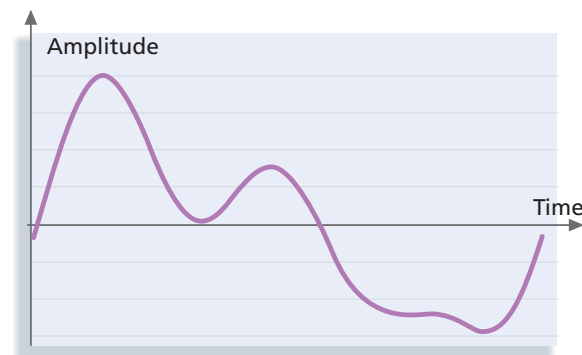

Corresponding frequency spectrum obtained by breaking down the signal into a Fourier series



f_1 is the fundamental or harmonic 1 and f_2, f_3 , are harmonics 2 and 3 of the complex signal. **By definition,** $f_2 = 2 f_1$, $f_3 = 3 f_1$.

Simple temporal signals resulting from the breakdown into Fourier series

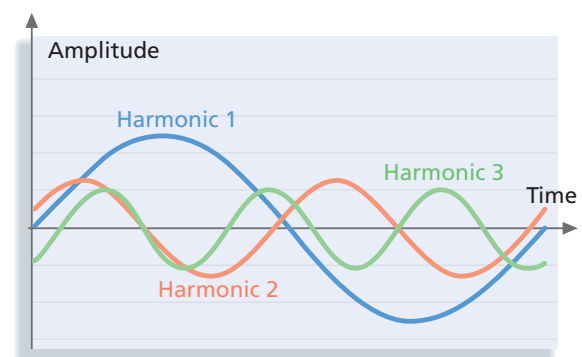

The number of simple signals selected to describe a very complex signal must be a compromise between the precision required and the computing time.

I.5

What is a natural mode?

It is said that an object reacts freely to mechanical stress when, after an initial shock, it is left to vibrate without further intervention. In other words, the **free response** is the way in which an object vibrates naturally without constraints. Free response is what is known as a **natural vibration mode**.

When an object is not subjected to a single initial excitations but to repeated ones, it is said that it is undergoing a **forced vibration** because the excitations enforces its own frequency. All objects are capable of vibrating at many different frequencies if these are imposed on them.

However, each object favours specific frequencies which, for a given force, produce vibrations with the largest amplitudes. These are the object's **natural frequencies**.



The closer the excitation frequency is to the object's natural frequency, the greater the amplitude of the vibrations. It is then said that the system is **resonating** with the excitation source. If the energy supplied by the exciter is greater than that dissipated by the system, the movement may "get out of control" and even become destructive*.

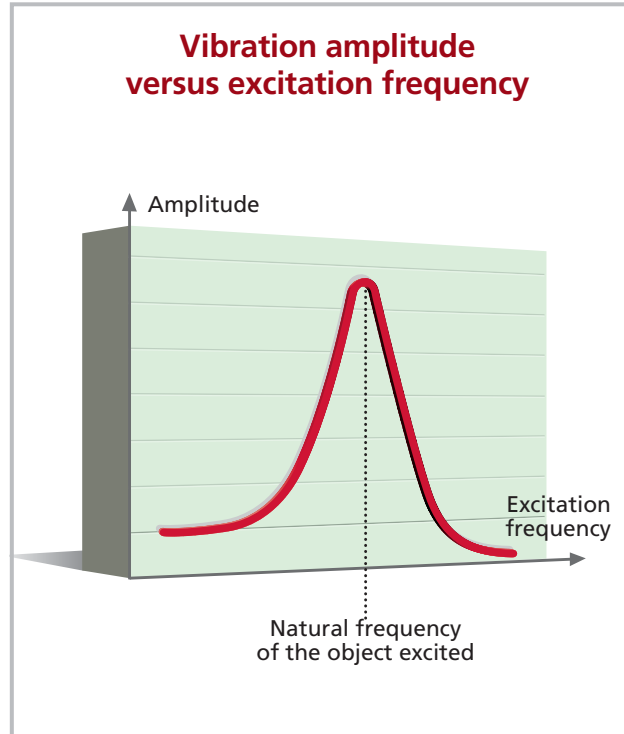

Each natural frequency is associated with a distortion pattern called a **mode shape**. The mode shape is the locus described by the extreme distortion positions around the position of equilibrium.

The natural frequency, its corresponding mode shape and its damping are together known as the object's **natural mode**.

* In 1850, the *Basse-Chaine* suspension bridge in France collapsed while a battalion of soldiers was crossing over it on the way to Angers to participate in a parade. The bridge started resonating with the battalion's marching rhythm and finally broke up, causing 224 deaths by drowning.

Mode shape of a pendulum

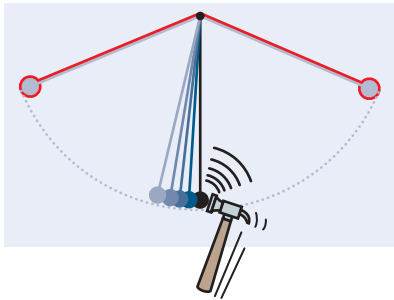

The mode shape of a pendulum is of the "to and fro in a plane" type. The natural frequency of a clock pendulum is 1 Hz. It describes a complete movement once every second.

Mode shape of a bowstring

The mode shape of a bowstring is a "half-sine". Its primary natural frequency depends on the tension, the length and the weight of the string. It generally lies between 50 and 200 Hz.

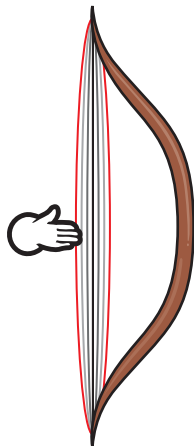

Comments:

- The amplitude of the mode shape depends on the energy supplied, in other words, in our examples, on the force with which the pendulum is struck by the hammer or with which the bowstring is plucked.
- The pendulum's vibration is visible to the naked eye but not the bowstring's because the eye is not capable of detecting movements with a frequency above 16 Hz. The eye simply perceives a standing image which stops it from seeing movement. This can be illustrated with a fan. When the fan turns slowly, our eyes can follow the movement of the rotating blades, but when they turn faster, the eye only sees a blurred disc.



■ THE NATURAL MODES OF A TAUT STRING

Let us take the example of an elastic, homogeneous string stretched taut between two points. If the string is hit with a hammer and left to vibrate freely, it distorts in the shape of a curve, like a "half-sine". What exactly is happening?

The distortion is propagated along the string on both sides of and away from the point of impact and the middle of the string is lower than both ends. Two vibratory waves form and propagate as shown by the red and blue arrows.

When each wave reaches the end of the string, it is reflected. The distortion is then inverted such that the middle of the string is higher than both ends. This process is repeated until the internal friction completely damps the vibration.

The string thus has a half-sine mode shape.

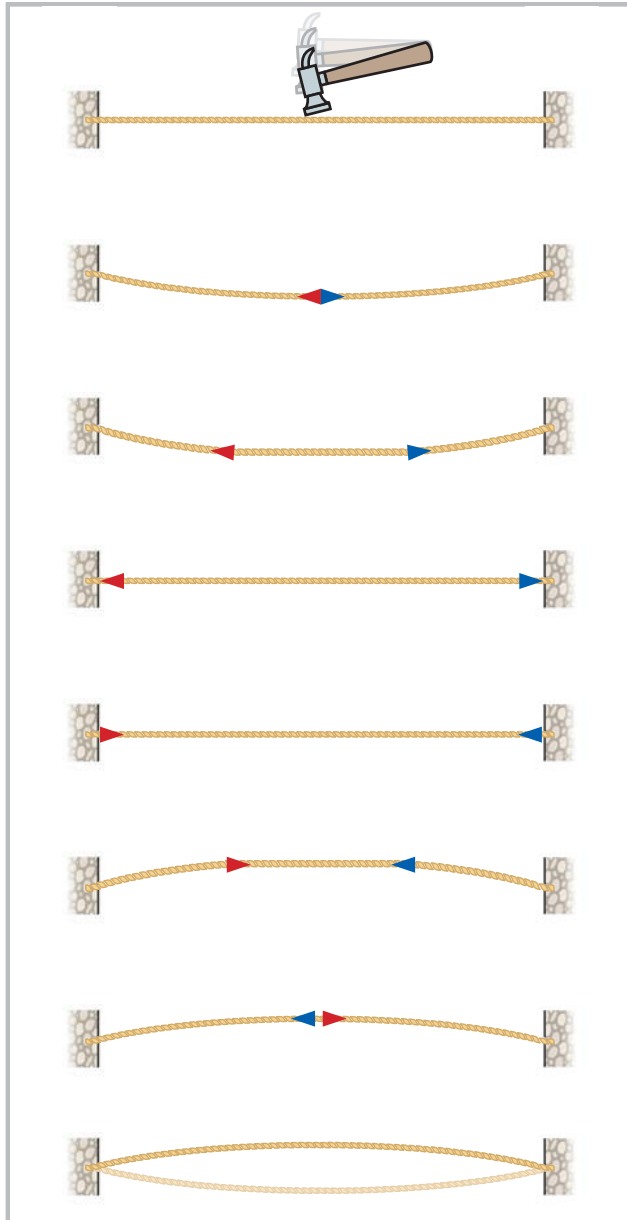

The half-sine is not the only mode shape possible for a taut string. It has several natural frequencies corresponding to as many mode shapes, all sinusoidal.

It may be shown that elastic, homogeneous materials have sinusoidal mode shapes. The propagation speed of the vibratory wave, written c , is a constant which depends on the mass per unit length of the string and on its tension.



When the string is excited at one of its natural frequencies, some points on the string do not move. These unmoving points are known as nodes. Others are distorted a maximum. These extreme points are known as anti-nodes.

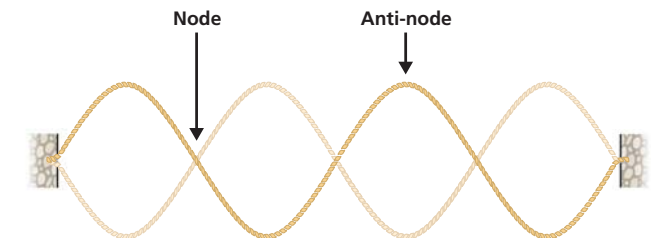

A vibration in which certain points of the vibrating object do not move is called a **standing wave**. Standing waves only occur at the object's natural frequencies.

First natural modes of a taut string

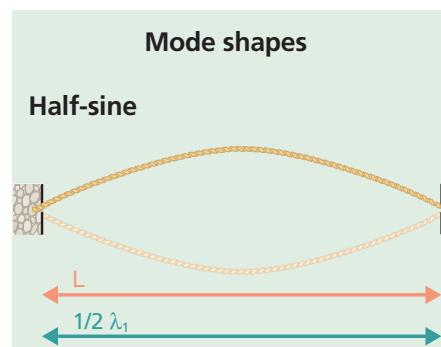

Wavelengths

$$\lambda_1 = 2L = \frac{2}{1} L$$

Natural frequencies

$$f_1 = \frac{1}{2} \frac{c}{L}$$

- The **wavelength** (λ) is the distance the wave needs to complete a distortion cycle (leaving the position of equilibrium, reaching a maximum, returning to the position of equilibrium, reaching a minimum and returning to the position of equilibrium).

- Both ends of the string are attached. They obviously form sine nodes. The number of half-sines which can occur between the two ends is thus always a whole number. λ thus depends directly on L.

- In a homogeneous medium, the speed of propagation (c) of a vibratory wave is constant. **The wavelength and frequency are related by the expression $c = \lambda \cdot f$**

- All **natural frequencies** are harmonics of the "fundamental", f_1 (in other words, multiples of the frequency of the first mode).

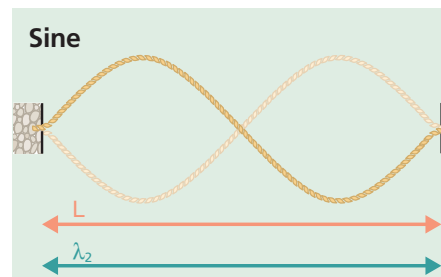

Wavelengths

$$\lambda_2 = L = \frac{2}{2} L$$

Natural frequencies

$$f_2 = \frac{2}{2} \frac{c}{L}$$

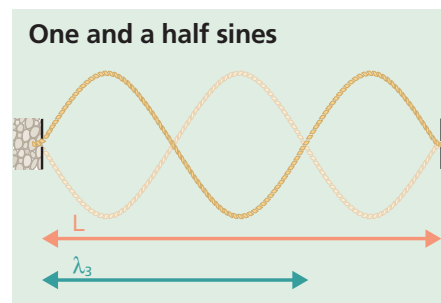

Wavelengths

$$\lambda_3 = \frac{2}{3} L$$

Natural frequencies

$$f_3 = \frac{3}{2} \frac{c}{L}$$

$$f_i = i \cdot f_1$$

General formula:

$$\lambda_i = \frac{2}{i} L$$

and

$$f_i = \frac{i}{2} \frac{c}{L}$$



... the natural modes of homogeneous, elastic materials

A little more information on...



The natural modes of a structure are the vibrations for which, if there is neither damping nor outside excitation, the sum of the internal loads and inertial forces is equal to zero. By definition, the distortion of an object vibrating at its natural frequency varies **over time** according to a sinusoidal law. We will also demonstrate that the distortion of homogeneous, elastic materials also varies **in space** according to a sinusoidal law.

The case of a vibrating string

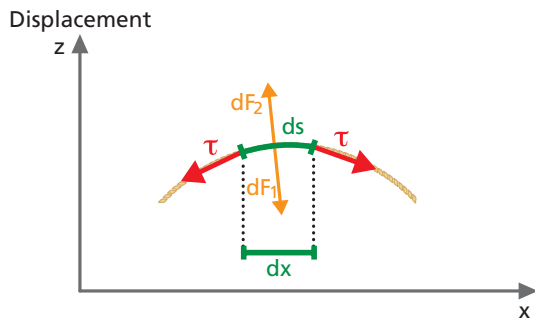

ds : segment of the string
 τ : tension
 dF_1 : force of return movement
 dF_2 : inertial force

Note:

since the distortions are small, it may be considered that $dx \simeq ds$

It may be shown that the force of return movement dF_1 affecting segment ds is such that:

$$dF_1 = \frac{\tau}{R} dx \quad \text{where } R \text{ is the string curvature radius}$$

The differential equation for this curvature radius can be written as follows:

$$\frac{1}{R} = \frac{d^2z}{dx^2} \quad \text{hence } dF_1 = \tau \frac{d^2z}{dx^2} dx$$

Segment ds is subject to an acceleration $\frac{d^2z}{dt^2}$ corresponding to an inertial force dF_2

such that: $dF_2 = -\rho \cdot dx \frac{d^2z}{dt^2}$ where ρ is the mass per unit length of the string

In the absence of damping and outside excitation, we have:

$$dF_1 + dF_2 = 0 \Rightarrow \tau \frac{d^2z}{dx^2} = \rho \frac{d^2z}{dt^2}$$

This is the differential equation of the balance of forces on ds .

This differential equation may be solved thus:

$$z = g(x) \cdot \sin \omega \cdot t$$

where $g(x)$ is a function representing the mode shape.

Let us determine $g(x)$:

By deriving $z = g(x) \cdot \sin \omega \cdot t$ twice in relation to x , we obtain:

$$\frac{d^2z}{dx^2} = \frac{d^2g(x)}{dx^2} \sin \omega \cdot t$$

By deriving $z = g(x) \cdot \sin \omega \cdot t$ twice in relation to t , we obtain:

$$\frac{d^2z}{dt^2} = -\omega^2 \cdot g(x) \cdot \sin \omega \cdot t$$

By placing the above results in the differential equation, we obtain:

$$\tau \frac{d^2g(x)}{dx^2} \sin \omega \cdot t = -\rho \cdot \omega^2 \cdot g(x) \cdot \sin \omega \cdot t$$

i.e. $g(x) = -\frac{\tau}{\rho \cdot \omega^2} \frac{d^2g(x)}{dx^2}$

The solution of this differential equation is indeed a sinusoidal equation in relation to x :

$$g(x) = a \cdot \sin \left(\omega \sqrt{\frac{\rho}{\tau}} x \right) + b \quad \text{where } b = 0 \text{ when the string is attached at } x = 0$$

A little more information on... ... the natural modes of a taut string



Review of the fundamental relations governing the propagation of vibrations

It may be shown that in any homogeneous medium, a vibration is propagated at a constant speed, written c , which depends on its tension τ and its mass per unit length ρ .

$$c = \sqrt{\frac{\tau}{\rho}}$$

It is also known that frequency (f) and wavelength (λ) are related to the speed of propagation thus:

$$c = \lambda \cdot f$$

Case of a taut string

We have also shown on page 23 that for a string stretched tight with both ends attached:

$$\lambda_i = \frac{2}{i} L$$

The following two general expressions are therefore true:

Frequency: $f_i = \frac{i}{2L} \sqrt{\frac{\tau}{\rho}}$

Mode shape: $g_i(x) = a \cdot \sin\left(i \cdot \pi \frac{x}{L}\right)$

Most objects have more than one natural mode. These modes depend on the dimensions, the density and the tension (or stiffness) of the object. They also depend on how the object's movements may be limited by its attachment points. These are called boundary conditions. In the case of the string we have just studied, the **boundary conditions** correspond to the fact that the string is fastened at both ends. If one end of the string were free, it would result in a sine anti-node rather than a node, producing a mode shape whose end would look like a fish's tail.

The natural modes of composite objects depend on the dimensions, density, tension and boundary conditions of each elementary component.



Any object will vibrate more easily and hence more strongly if it is subjected to a vibration source with a frequency close to one of its natural frequencies. Tyres are no exception to this rule.



Boundary conditions

The radial tyre may in fact be compared to the simplified model of a taut string curved around into a circle shape whose mode shapes may also be described by sinusoidal equations.

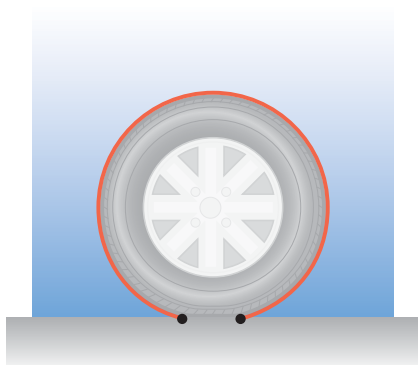

Belt stretched by inflation pressure

The natural modes of a tyre will be studied in more detail in chapter III. As for the string, these natural modes depend on the mass, dimension and stiffness of the tyre.

Boundary conditions are all the conditions which constrain the behaviour of an object.

Example of boundary conditions for a flexible blade

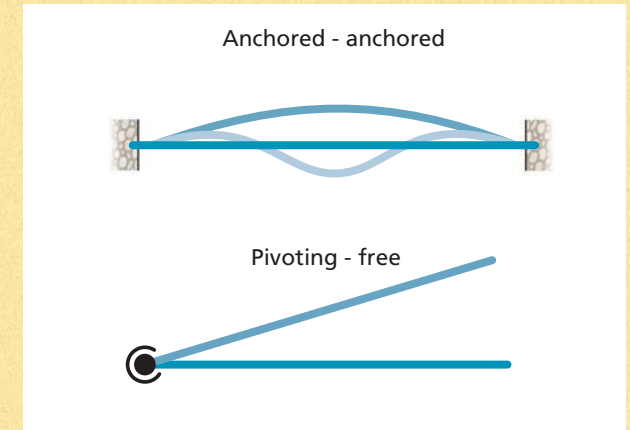
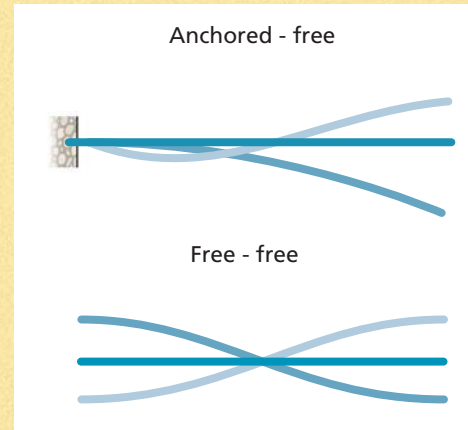

The effect of boundary conditions on the mode shape of a string

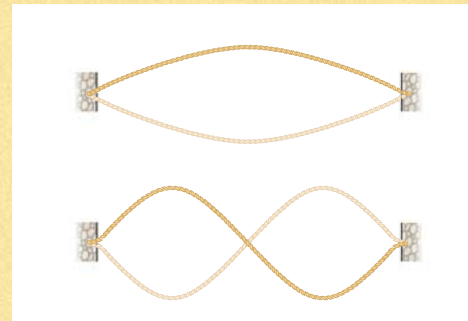

The mode shapes of a string attached at both ends (left) include a whole number (i.e. an integer) of half-sines. The mode shapes of a string attached at only one end (right) are made of quarter-sines, hence the "fishtail shape".

I Vibrations

DEFINITIONS

When a body undergoes a shock, it starts to vibrate. A vibration is an alternating movement around a position of equilibrium. It is defined by its amplitude and frequency. **Amplitude A** corresponds to the maximum level of a vibration. For a **mechanical vibration**, A may be a displacement, expressed in metres, or an acceleration, expressed in m/s^2 .

Frequency (f) expresses the number of complete cycles described by the vibrating body around its position of equilibrium in one second. It is expressed in hertz (Hz).

If a vibration is not maintained, it finally "dies down". This is known as **damping**.

ACOUSTIC VIBRATIONS

The sounds we perceive are the result of vibrating air molecules which produce variations in the surrounding air pressure around the atmospheric pressure value. This is **sound pressure**, expressed in pascals ($10^5 Pa \approx 1 bar$).

The level of sound pressure may also be expressed using a logarithmic scale: the **decibel (dB)**. An increase of 6 dB corresponds to a doubling of the sound pressure.

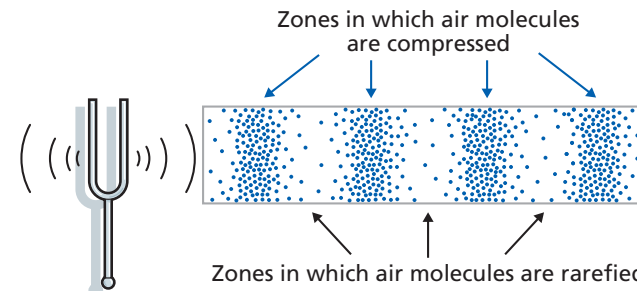
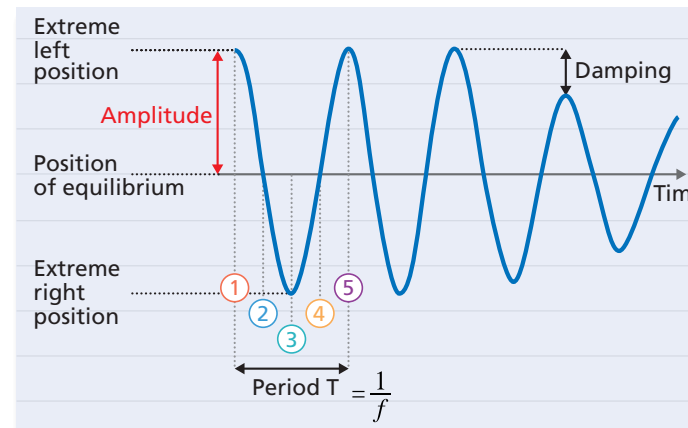
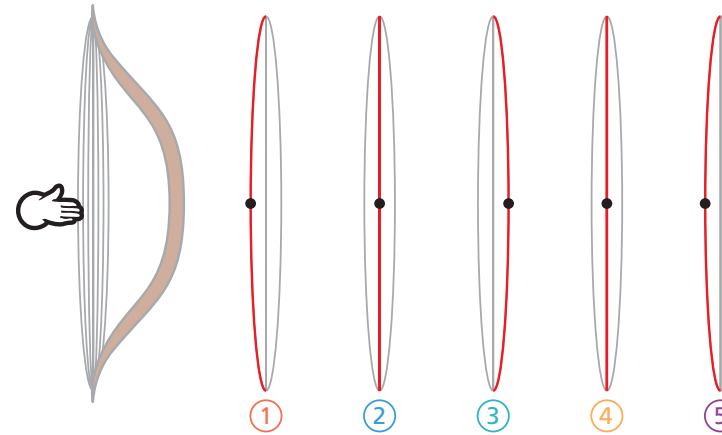
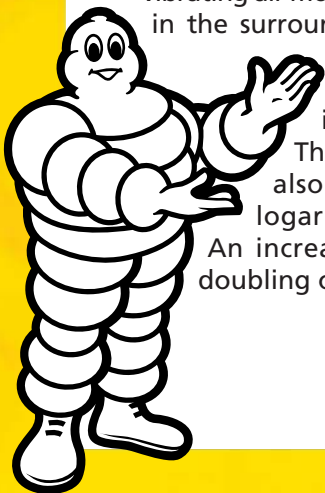

I Vibrations

FOURIER TRANSFORM

Mechanical or acoustic vibrations are rarely pure, continuous vibrations able to be described by a simple sinusoidal signal. However, any complex periodic vibration may be broken down into a series of simple sinusoidal signals using a mathematical tool called a **Fourier transform**.

Complex signal obtained by recording

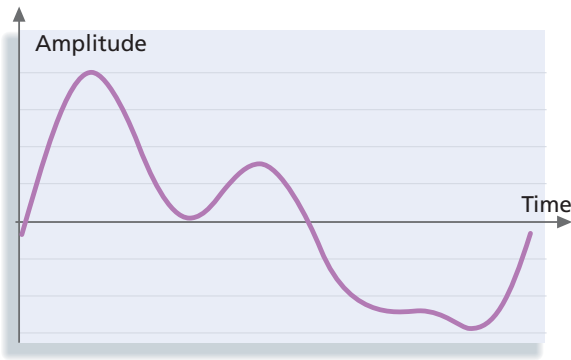

Corresponding frequency spectrum obtained by a Fourier transform



where f_1 is the fundamental or harmonic 1 and f_2 , f_3 , harmonics 2 and 3 of the complex signal.
By definition, $f_2 = 2 f_1$, $f_3 = 3 f_1$.

NATURAL FREQUENCIES

Any object is capable of vibrating at many different frequencies if forced to do so.

However, each object favours the frequencies which for a given force produce the largest vibration amplitudes. These are the **natural frequencies**, also known as **resonance frequencies**.

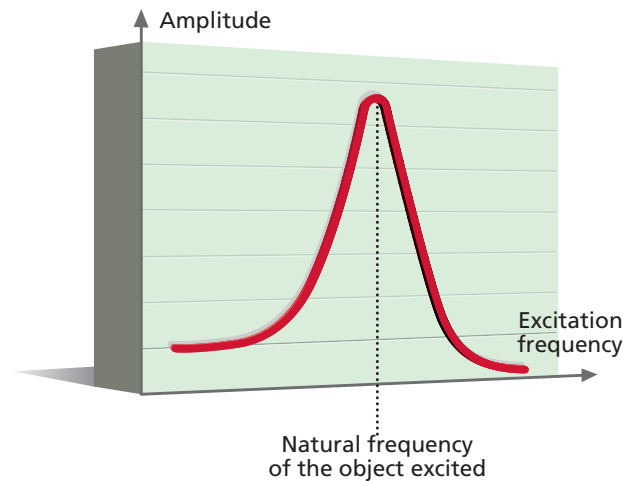

MODE SHAPES

Each natural frequency has a corresponding distortion pattern called a **mode shape**. Homogeneous, elastic objects, to which the tyre may be compared in terms of vibrations, all have sinusoidal-type mode shapes.

Natural modes depend on dimensions, mass, tension and boundary conditions.

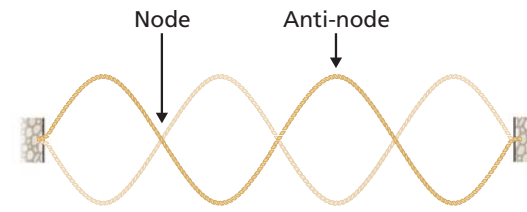

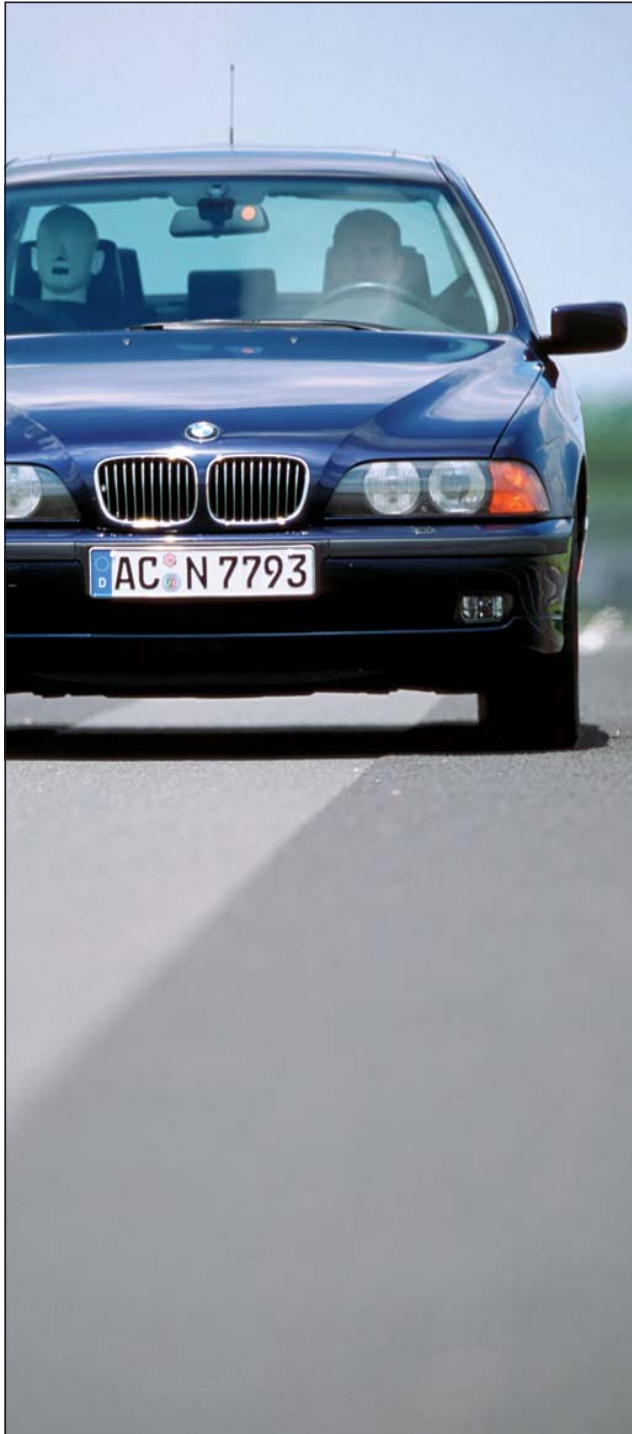

II *Human perception*

When we touch a vibrating object, we can feel the mechanical vibration.

If the vibration is transmitted by the air to our eardrums, we can also perceive an acoustic vibration, in other words sound. In both cases, our perception depends on several factors such as the magnitude and frequency of the vibration.



II.1

Human sensitivity to vibrations

MECHANICAL VIBRATIONS

People's awareness of the vibrations of an object which is touching them, depends on four factors:

- the **frequency** of accelerations;
- their **magnitude**;
- the **part of the body** which feels the vibrations (hands, feet and the back each react differently);
- the **direction of the stress**.

Weighting factors are used to model this sensitivity.

ACOUSTIC VIBRATIONS

Sound waves are characterised by three parameters: **frequency**, **amplitude** and the **shape of the vibratory signal**. When a sound wave reaches the ear, it causes a sound sensation which is characterised by:

- the **pitch**, which is the highness or lowness of a sound. Pitch depends on the frequency of the waves producing it;
- its physiological intensity, i.e. **loudness**, which depends on the amplitude;
- its **timbre** (also known as tone colour), which depends on the shape of the vibratory signal, in other words on its harmonic composition. It is the timbre which makes it possible to distinguish the sound of a violin from that of an oboe, for example (a single note emitted by different instruments always has the same fundamental frequency but different harmonics).



II.2

How frequency affects the human perception of vibrations

The eyes and inner ear mainly perceive vibrations with frequencies between **0.1 and 0.5 Hz**. These frequencies are typical of phenomena such as the pitching or rolling of a boat in a swell or that of a car being driven over a road surface with long irregularities. These vibrations can cause **motion sickness**.

The "large organs" such as the arms, legs, back, heart or stomach mainly perceive vibrations with frequencies between **0.5 and 60 Hz**. The human body then registers **shocks** and **jolts**.

The skin mainly perceives vibrations with frequencies between **60 and 100 Hz**. Such frequencies are typical, for instance, of an engine. In human beings, they produce a **prickling sensation**.

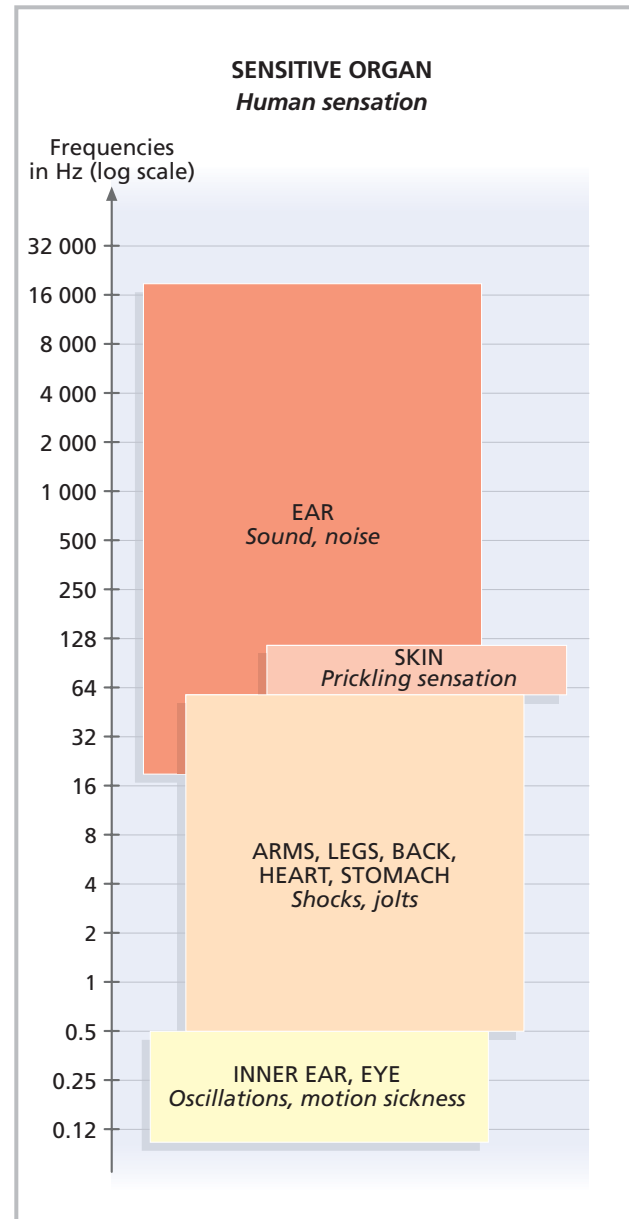

The human ear perceives **sounds** with a frequency between 20 and 20 000 Hz.

- from 20 to 200 Hz, they are low frequencies;
- from 200 to 2 000 Hz, they are medium frequencies;
- from 2 000 to 20 000 Hz, they are high frequencies.

Below 20 Hz, they are known as **infrasounds** and above 20 000 Hz they are **ultrasounds**.

Examples of fundamental frequencies for the piano and the human voice

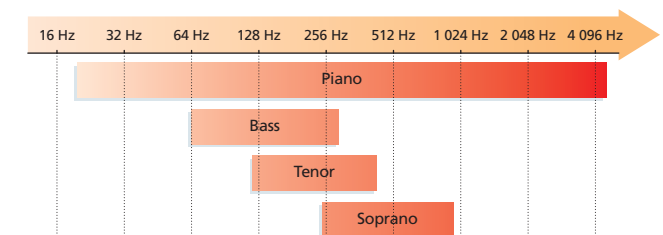

II.3

How amplitude affects the human perception of vibrations

■ ACOUSTIC VIBRATIONS

The human ear is sensitive to sound pressure ranging between the **threshold of hearing** P_0 ($2 \cdot 10^{-5}$ Pa) and the **threshold of pain** (20 Pa). The latter value is a million times bigger. The ear's perception is not linear. Whenever sound pressure increases by 10 dB, the ear perceives a twofold increase in volume.

■ MECHANICAL VIBRATIONS*

Fifty percent of a healthy population do not detect a mechanical vibration with an amplitude below 0.015 m/s^{2**} . This **perception threshold** is equal to about a thousandth of the acceleration of gravity (0.0015 g).

According to the situation, a vibration may be considered unacceptable, or pleasant. Many factors (such as what the person is doing at the time) simultaneously affect the way in which discomfort may be felt or tolerated. Nevertheless the following figures give some idea of common perception levels:

$< 0.315 \text{ m/s}^2$	not uncomfortable	
$0.315 \text{ to } 0.63 \text{ m/s}^2$	a little uncomfortable	-> i.e. $\approx 0.05 \text{ g}$
$0.5 \text{ to } 1 \text{ m/s}^2$	fairly uncomfortable	
$0.8 \text{ to } 1.6 \text{ m/s}^2$	uncomfortable	-> i.e. $\approx 0.1 \text{ g}$
$1.25 \text{ to } 2.5 \text{ m/s}^2$	very uncomfortable	
$> 2 \text{ m/s}^2$	extremely uncomfortable	-> i.e. $\approx 0.2 \text{ g}$

* Source: Ref. [2], Appendix C

** The perception threshold varies widely from one person to another. For a median perception threshold of approximately 0.015 m/s^2 , 25 % of the responses may range from about 0.01 to 0.015 m/s^2 , and another 25 % from 0.015 to 0.02 m/s^2 .

Common acoustic pressure levels

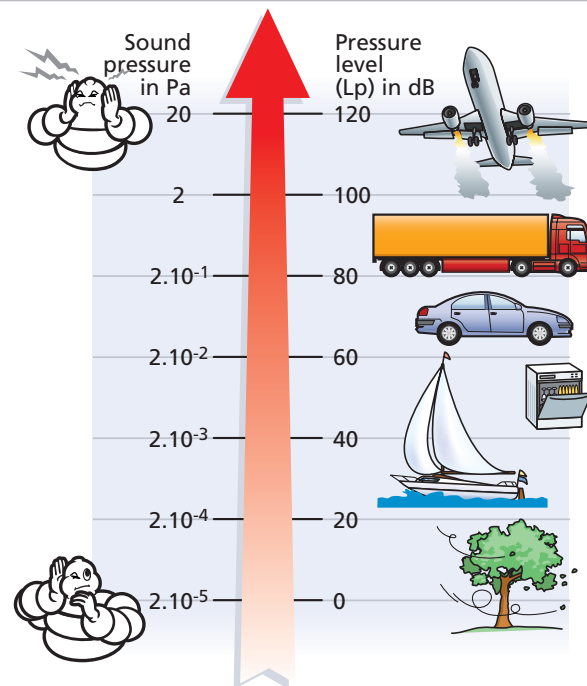

Common mechanical vibration levels

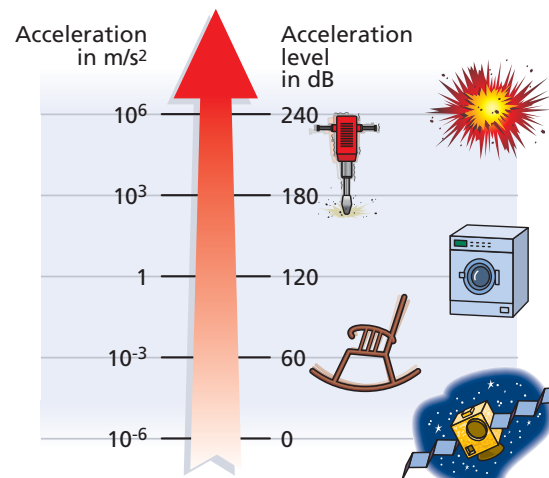

II.4

Human sensitivity to acoustic vibrations

HUMAN HEARING RANGE

In order for a frequency to be audible to human beings, it must not only lie between 20 and 20 000 Hz but its magnitude must also lie between the **threshold of hearing** ($2 \cdot 10^{-5}$ Pa for a pure sound at 1 000 Hz, i.e. 0 dB) and the **threshold of pain** (saturation of the ear at 140 dB for a pure sound at 1 000 Hz and 120 dB at 5 000 Hz). The **timbre**, i.e. the harmonic composition of the sound signal, enables the ear to distinguish between two sounds with the same fundamental frequency.

THE DECIBEL (A) OR dB(A)

Quantifying a noise requires taking the ear's sensitivity to frequency into account. At the same intensity, low sounds (low frequency) are less perceptible to the human ear than high sounds (high frequency). The ear acts as a **filter**. This is why sound measurements are corrected to properly determine the way in which the ear perceives noise. The most widely used correction system for transportation, is the **A-weighting** which is used to measure the noise in A-weighted decibels written dB(A).

Isosensitivity curves for the human ear

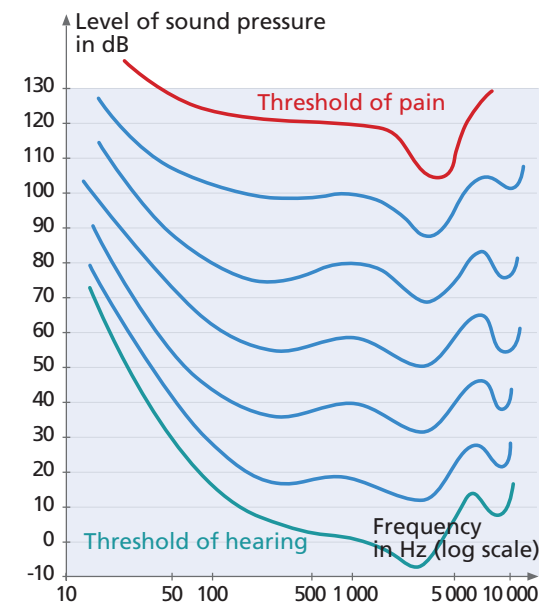

Statistical studies have determined the above isosones. These curves represent the ear's average sensitivity to permanent pure sounds as a function of frequency and magnitude. For a given sound pressure level the ear's sensitivity depends on the frequency. For a given frequency, the ear's sensitivity increases logarithmically (or almost) with sound pressure. These curves are used to determine weighting coefficients which can then be used to correct measured sound levels to better determine the way in which human beings perceive sound. The most common is the A-weighting based on the isosonic curve passing through the intersection of 60 dB and 1 000 Hz.

Human hearing range

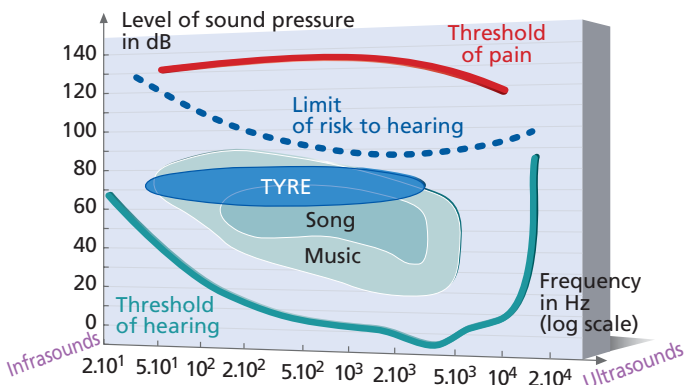

If the hearing risk limit is exceeded for long enough, irreversible damage may occur. This damage most often leads to the threshold of hearing being increased with a corresponding hearing loss for sounds with low volume.

The frequency range covered by the tyre, with sound pressure levels from 60 to 80 dB, is very close to that of song.

Weightings

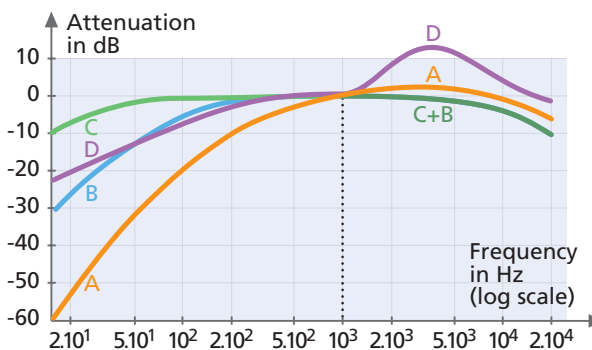

The A-weighting is used for "ambient" sounds, such as those in a house. By convention, it is also used for transport and road traffic noise. There are three other systems: the dB(B), used for intermediate sounds, dB(C), for very loud sounds and dB(D), for extremely loud sounds such as aircraft.



■ PEAKS

The fact that one sound source makes more noise than another does not necessarily make it more disturbing. The disturbance may also be due to **peaks**, in other words the concentration of energy at certain points of the frequency spectrum.

In a very quiet room, such as a bedroom, the least sound is perceptible. Even the slight ticking of an alarm clock can be disturbing. On the other hand, when in a noisier place, such as a kitchen in which the oven and extractor fan are on, these sounds overlap and no one sound is dominant. There is less disturbance even though the intensity of the sound is greater. This is known as **white noise**. The overall noise in a moving vehicle is quite substantial, but is not necessarily noticed. If a sound **peaks** above the general noise level though, it is noticed.

Peaks

The power of certain frequencies is much higher than the average power. The human ear is particularly sensitive to these peaks.

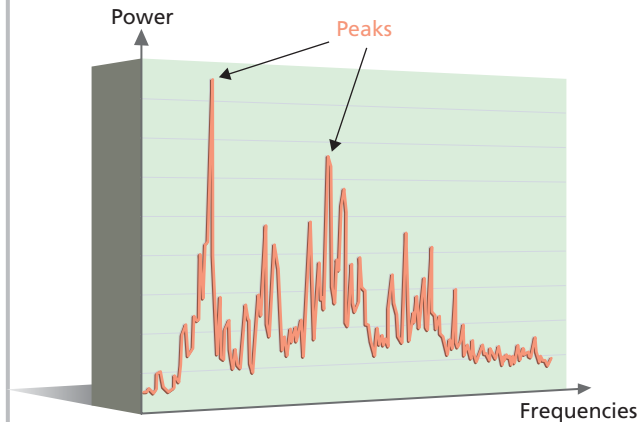

White noise

The acoustic power is spread uniformly over the whole frequency range. There are no above-average frequency peaks and the ear cannot identify any specific sound.

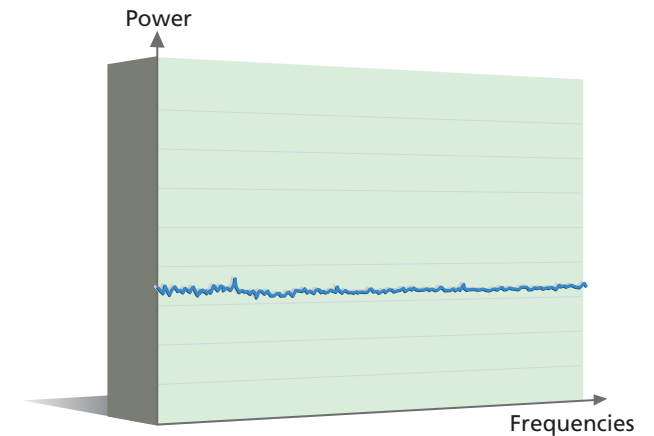

II.5

Human sensitivity to mechanical vibrations

Just as the human ear is, for a given intensity, more sensitive to high frequencies than to low frequencies, the human body on the whole is more sensitive to vibrations with frequencies between 0.5 and 50 Hz than to other frequencies. However, this filter effect is more complex than for the ear. It depends on the direction of stress and the **organ stressed**. A British standard has defined a number of weightings which take these different sensitivities into account.

On the whole, the human body reacts differently to frequencies according to whether the stress is exerted vertically (Z axis) or horizontally (X and Y axes).

Overall sensitivity of the human body to mechanical vibrations versus direction of stress

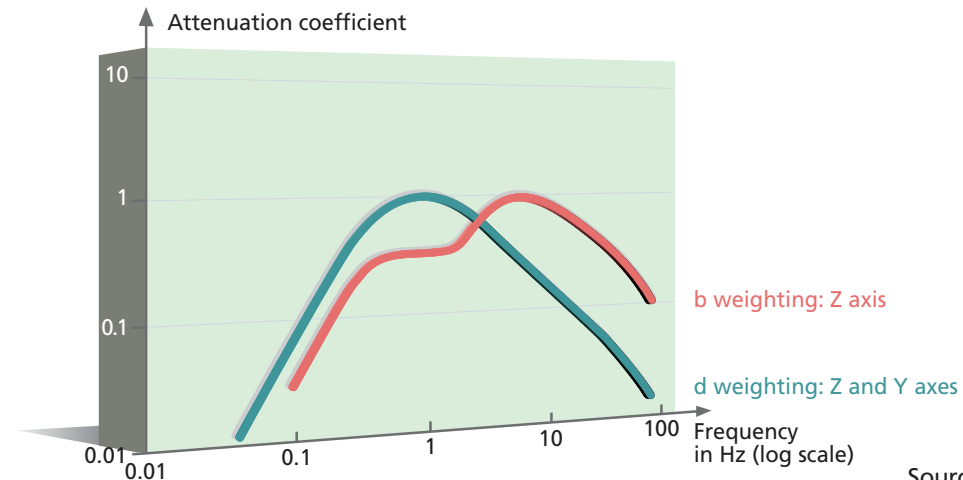

Source: BSI, ref. [2]

Position of the 3 stress axes, X, Y and Z

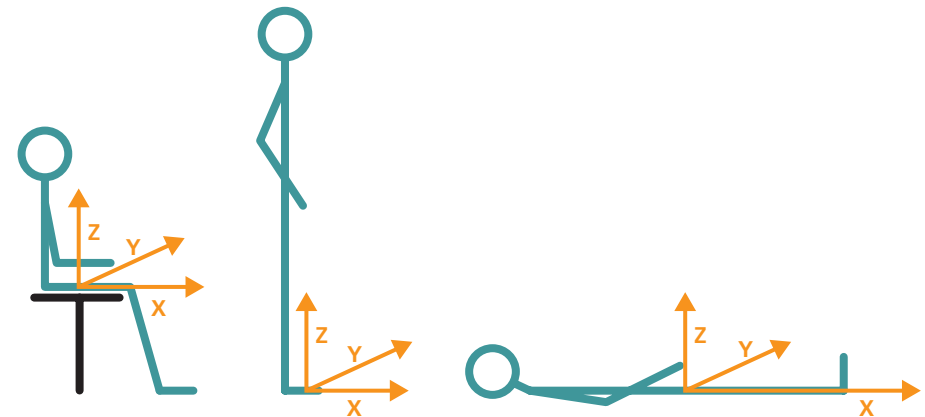

Hypotheses:

- subject seated: vibrations coming through the seat
- subjects standing and recumbent: vibrations coming from the ground

However, in situations in which a person is seated and simultaneously subjected to complex vibrations affecting the seat, backrest, feet and hands, as in a vehicle, we need to consider each **organ stressed** to assess the feeling of discomfort. This is because the hands and feet do not filter vibrations in the same way as the back or the seat.

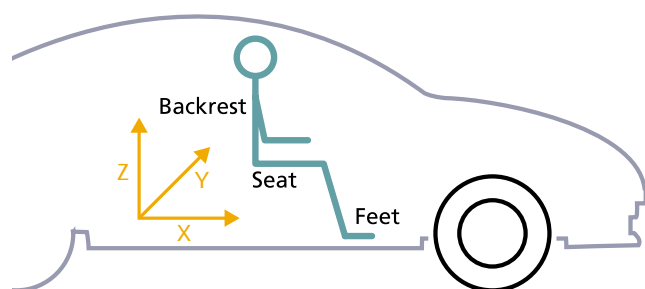

Moreover, just as the whole body reacts differently depending on the direction of stress, so some organs are sensitive to a greater or lesser extent.

In order to assess the vibrations felt by a human being inside a vehicle, the recorded values must subsequently be weighted according to the frequency, the organ in question and the direction of stress.

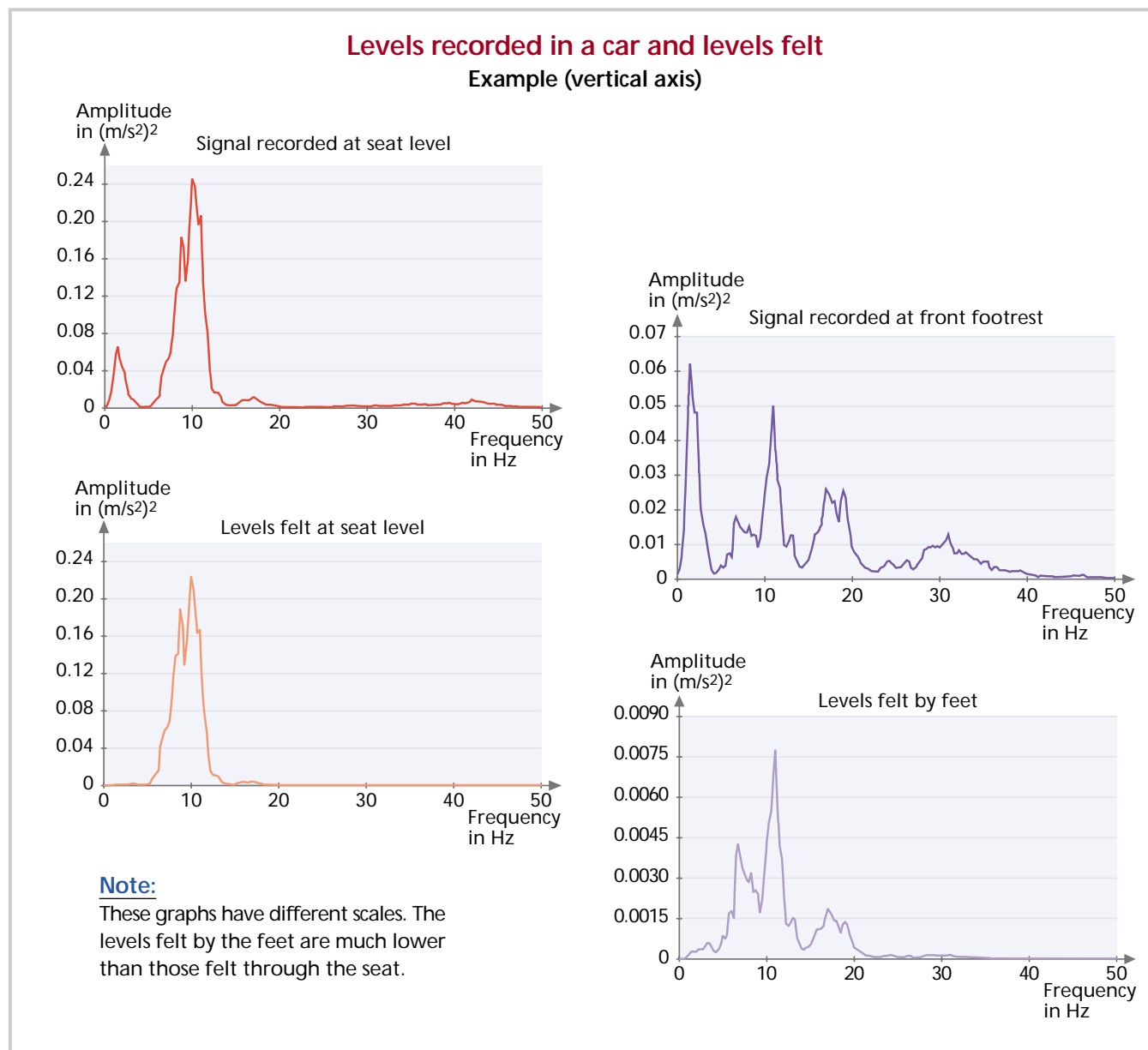

.... weightings and their application to automobile comfort



When modelling the discomfort felt in a vehicle, the recorded values have to be corrected in two stages.

- 1 An initial attenuation coefficient is applied, depending on frequency, in accordance with the BSI weightings shown below.
- 2 These "weighted values" must then be multiplied by a second attenuation coefficient, which is specific to the direction of stress for each region stressed.
- 3 Overall comfort indices may then be calculated.

Sensitivity of human organs to mechanical vibrations, in relation to stress direction

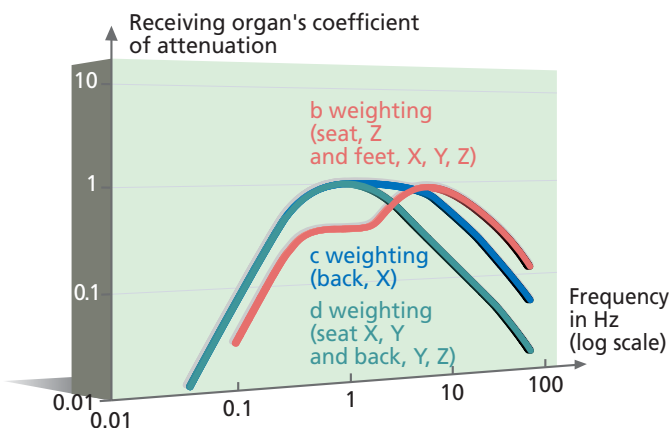

Current international research is being done to define weightings which can be applied to hands.

Weightings and multiplying coefficients recommended by the BSI standard

	Region stressed		
	Seat	Back	Feet
X	d weighting Coeff. 1	c weighting Coeff. 0.8	b weighting Coeff. 0.25
Y	d weighting Coeff. 1	d weighting Coeff. 0.5	b weighting Coeff. 0.25
Z	b weighting Coeff. 1	d weighting Coeff. 0.4	b weighting Coeff. 0.4

Source: BSI, ref. [2]. Scope: assessing discomfort in the 0.5 to 80 Hz frequency range.

Stages in calculating a comfort index

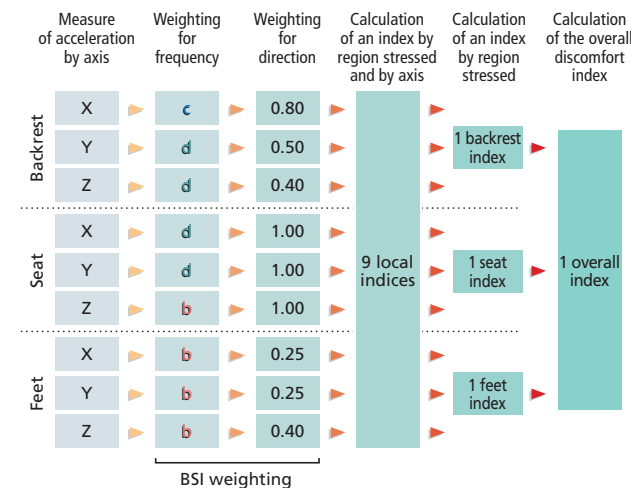

II Human perception

Human sensitivity to mechanical and acoustic vibrations depends on their magnitude and frequency.

MAGNITUDE:

The human body can perceive vibrations upwards of 0.015 m/s² and considers them uncomfortable around 1 m/s².

The ear is sensitive to sound pressure from 2.10⁻⁵ Pa (i.e. 0 dB) to 20 Pa (i.e. 120 dB).

FREQUENCY:

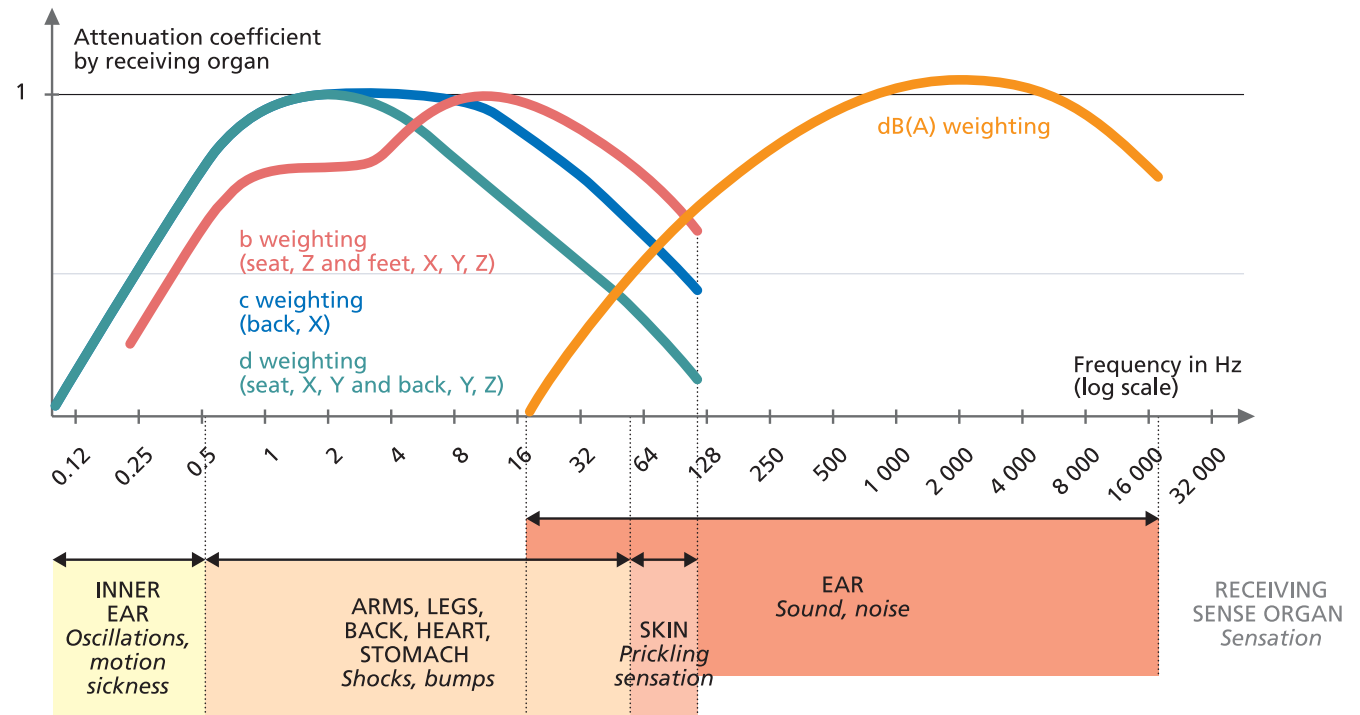

NB:

Even if the values given opposite are statistically representative of human perception, remember that perception varies widely from one person to another.

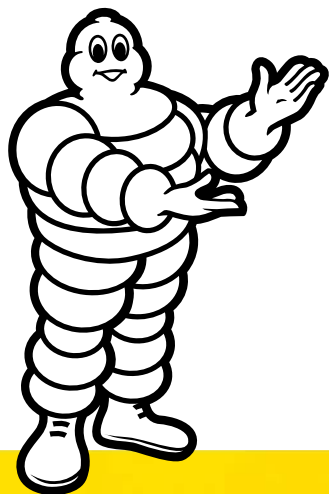

The human body is particularly sensitive to mechanical vibrations with frequencies between 0.5 and 50 Hz. This sensitivity depends on the part of the body affected and the direction of stress.

At a given level of intensity, the human ear perceives high-pitched sounds (high frequency) better than low-pitched sounds (low frequency).



III *The tyre: a vibration filter*

The invention of the pneumatic tyre over a hundred years ago marked a significant breakthrough in automobile comfort, which had previously been limited by the use of plain wheels, with or without solid tyres. Pneumatic tyres compensate for irregularities in road surfaces and filter out vibrations. However, in certain conditions, this "vibration filter" can itself vibrate and transmit vibrations.

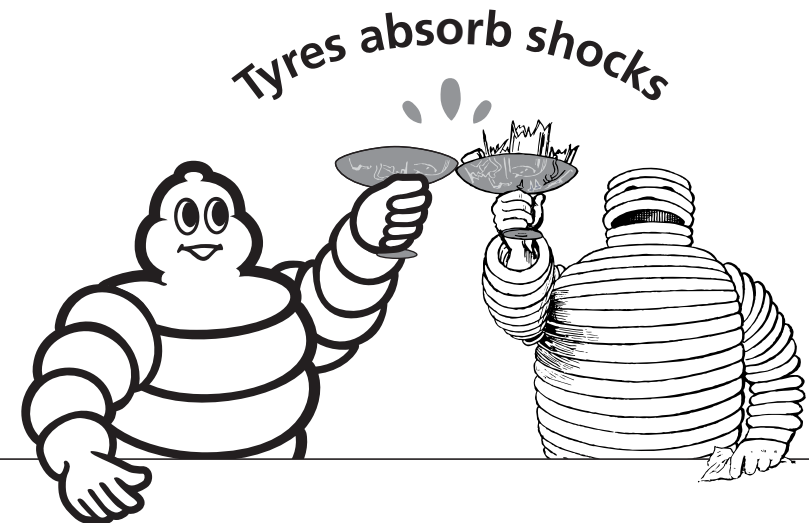

There are several sources of mechanical and acoustic vibrations on vehicles, such as the engine, transmission system, aerodynamic drag, vibrations of structural parts, and the contact between tyres and the road.

This document will only investigate vibrations caused by tyres rolling on a road, also called "tyre/road interaction".

Automobile manufacturers have long been battling against vibrations caused by the vehicle itself. Over the years engines have become quieter, and car body shapes have become more aerodynamic. Paradoxically, whenever the overall vibration level of the vehicle itself decreases, the proportion of noise from tire/road interface increases, unless tyre noise decreases to the same extent.

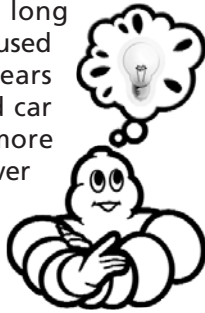

This is why, although the tyre is already a source of comfort, tyre engineers keep striving to further improve it. In order to make tyres more comfortable, engineers have to fully understand how, when and why tyres vibrate.

Sources of vibrations on a truck

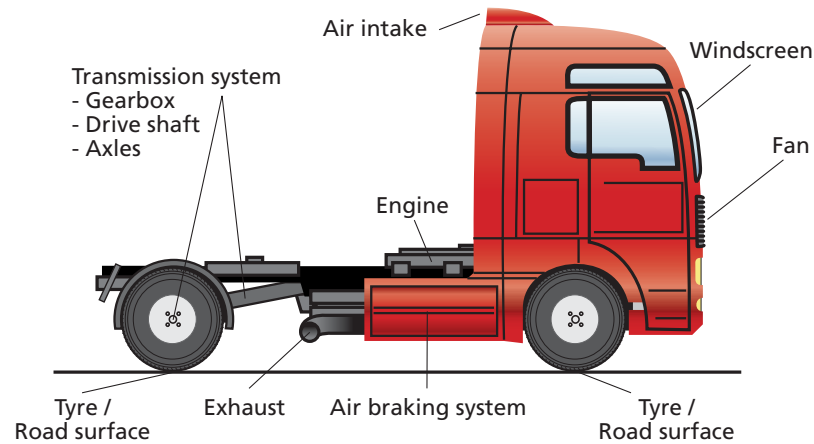

A vehicle is a complex system made up of many different parts. It has several natural frequencies resulting from the combination of its components' natural frequencies.

Vehicle response as a function of excitation frequency

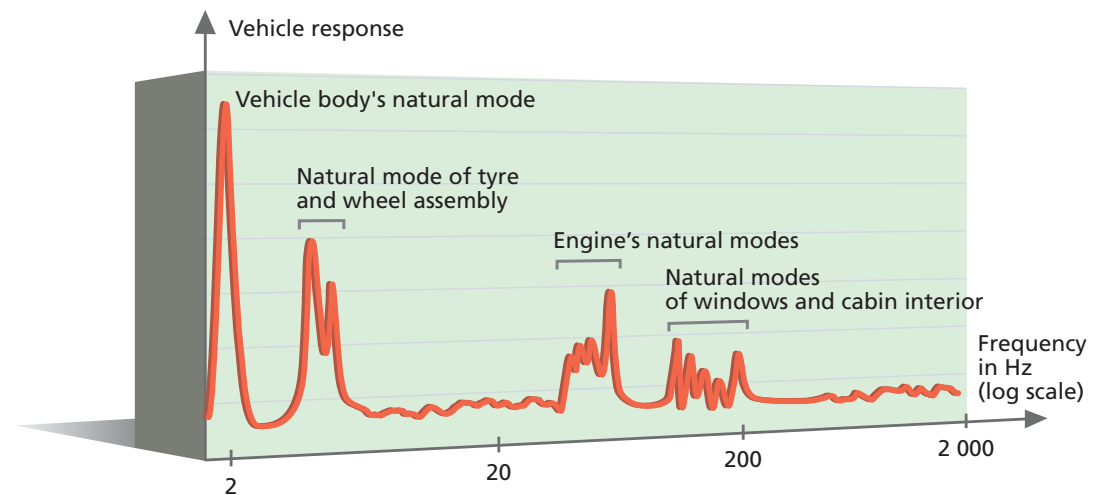

III.1

The tyre: a deformable system

The tyre is a complex product made of elastomers, metal and textile reinforcements. Whereas elastomers can be distorted to a greater or lesser extent in all directions, the reinforcing materials can only be distorted in certain directions. Although they can bend, they cannot stretch. Reinforcing thus implies **directional stiffness**, which the engineer exploits to optimise the tyre's resistance to distortion in three directions: radial, transversal and circumferential.

A balance has to be struck between flexibility and stiffness. The tyre's capacity to absorb shocks from uneven or rough road surfaces depends on its own distortion capacity. Tyres are thus designed to be flexible along the radial axis.

However, if the tyre is too 'soft' and distorts too much, it can no longer keep the vehicle on its trajectory. This is why tyres are designed with transversally rigid belts.



Directional stiffness



Radial, transversal and circumferential stiffness

Radial stiffness refers to the tyre's capacity to resist distortion under the effect of forces applied parallel to the wheel **radius**, whence the term radial.

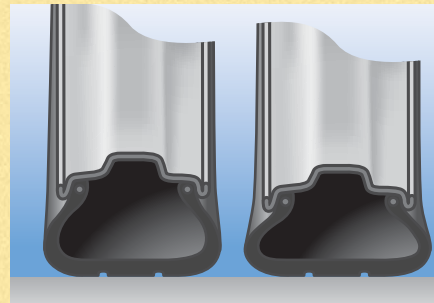

Example of radial distortion caused by tyre compression

Transversal stiffness refers to the tyre's capacity to resist distortion under the effect of forces applied perpendicularly to the plane of the wheel.

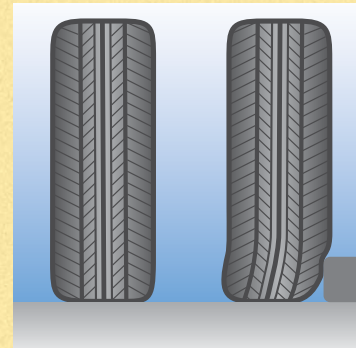

Example of transversal distortion caused by an obstacle

Circumferential stiffness refers to the tyre's capacity to resist distortion caused by a relative rotation between the wheel and the tyre belt.

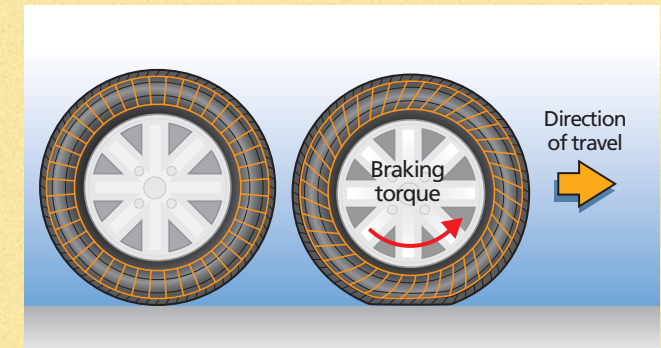

Example of distortion due to braking

III.2

How the tyre contributes to comfort



When rolling, the impact of the tread pattern and the distortion of the tyre caused by an uneven or rough road surface cause small shocks in the tyre. These shocks make the tyre structure and/or surface vibrate. The tyre transmits its vibrations to the vehicle and/or to the surrounding air. Depending on the excitation frequency, the tyre may:

- increase comfort : in general, the tyre attenuates the extent of the distortion and damps vibrations through energy dissipation because of the rubber's visco-elastic nature;
- increase discomfort: at frequencies close to those of its natural modes, the tyre amplifies vibrations. This amplification causes even more discomfort when the frequency also corresponds to one of the vehicle's natural frequencies. If these frequencies are within the range of human perception, they cause discomfort for passengers.

To improve comfort, engineers thus have to design a tyre capable of attenuating vibrations whose frequency and amplitude fall within the range of human perception. Ideally, these vibrations should be reduced to levels below those which are perceived as uncomfortable by human beings. One way of achieving this is to avoid any match between the tyre's natural frequencies and those of the vehicle.

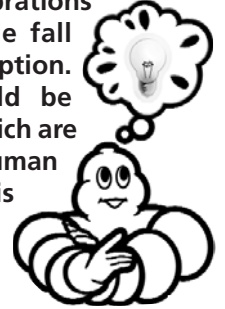

The tyre is a complex system, however, and can be distorted to a greater or lesser extent in all directions. Its vibration is similarly complex as it has several natural modes. To improve comfort, it is thus necessary to begin by accurately describing the tyre's vibration.

Comfort or discomfort?

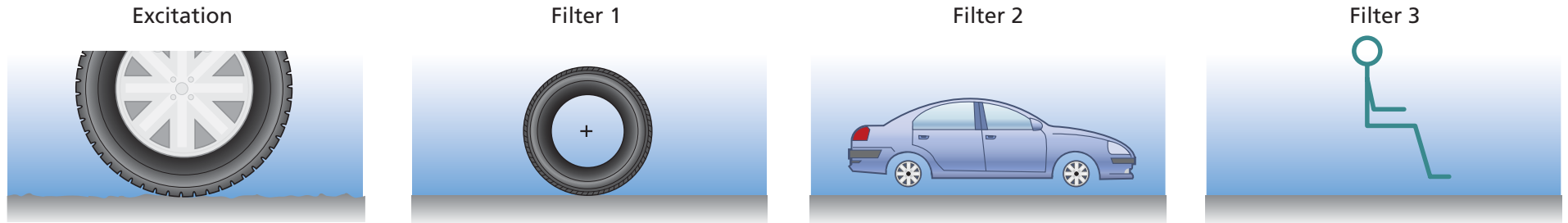

Road surface and tread pattern interaction excites the tyre



The tyre filters or transmits vibrations to the vehicle



The vehicle filters or transmits vibrations to the passengers



The sensitivity of the passenger depends on the frequency and amplitude of the vibrations

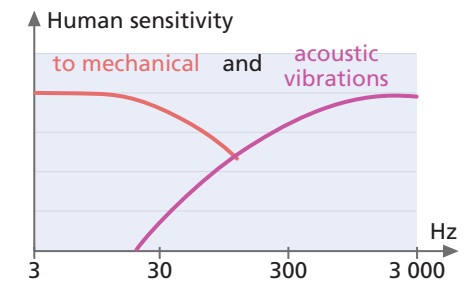
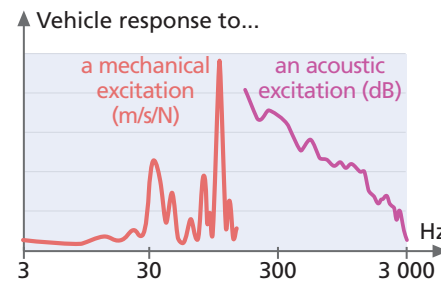
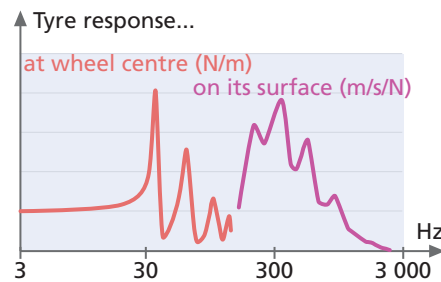
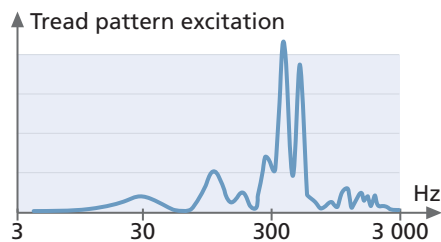
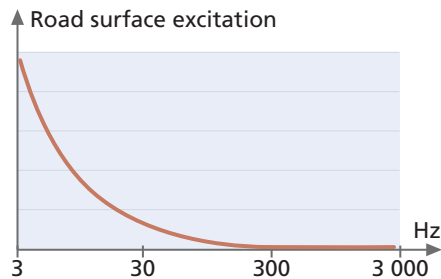

Passengers feel uncomfortable if the frequency and amplitude of vibrations reaching them fall within their range of perception.



III.3

Tyre vibration

A tyre's vibratory behaviour varies according to frequency.

Below 30 Hz, the tyre acts like a spring.

Between 30 Hz and 250 Hz, the tyre may be considered to be a multi-mode vibratory system as it has several natural mode shapes, all of which may be grouped into two main categories: **radial modes and transversal modes**.

At more than 250 Hz, the tyre mainly vibrates near the contact patch.

III.3.1

Below 30 Hz: spring-type behaviour

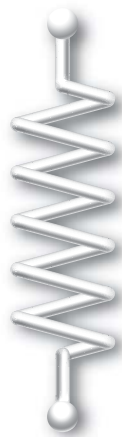

Below a frequency of 30 Hz, the tyre behaves rather like a spring positioned between the road surface and the vehicle. When it meets an obstacle, it is first compressed and then it relaxes. As the tyre compresses, it partially absorbs the shock thus reducing the movements of the car body.

The extent to which the tyre is compressed depends on its radial stiffness. Below 30 Hz, the significant comfort parameter is thus the tyre's radial stiffness when rolling over an obstacle.

MEASURING THE RADIAL STIFFNESS OF A TYRE ROLLING OVER AN OBSTACLE

The tyre is rolled on a drum at a speed of 2 km/h. Attached across the width of the drum is a 1 cm x 2 cm x 30 cm cleat. The centre of the wheel is immobilised and the forces exerted there are measured when the tyre rolls over the cleat. The forces are measured along two axes: the vertical axis (F_z) and the longitudinal axis (F_x).

The more flexible the tyre, the smaller the forces measured and, under road conditions, the smaller the accelerations transmitted to the wheel centre and the car body.

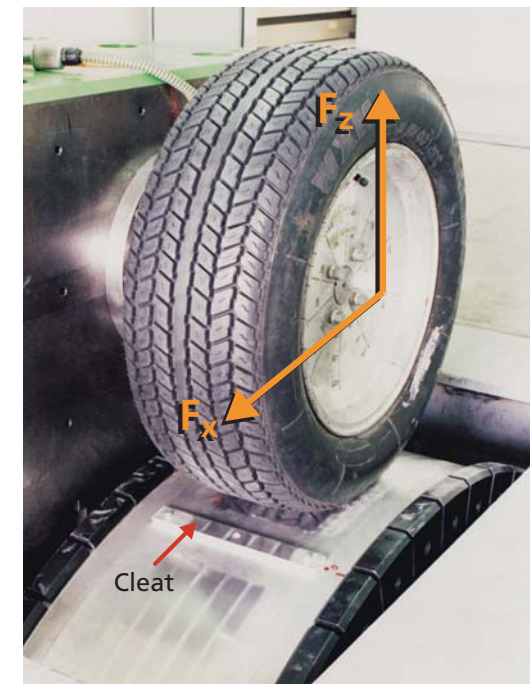

III.3.2

Between 30 and 250 Hz: a tyre's natural modes

■ IDENTIFYING A TYRE'S NATURAL MODES

The tyre, mounted on a wheel, is compressed against a vibrating plate. The wheel centre is immobilised and accelerometers placed at regular intervals around the tyre's circumference.

The plate is then vibrated along the chosen axis, longitudinal (X), transversal (Y), vertical (Z) or

rotated around a vertical axis (OZ). The excitation is a "white noise" covering a wide frequency band (0 to 500 Hz). Each accelerometer records 3 frequency responses (along 3 translation axes).

The processing software converts the recorded accelerations into displacements (of the order of 0.1 to 1 mm) then displays a visual representation of the tyre's **mode shapes** (see following page).

It is also possible to measure the loads transmitted to the wheel centre and to determine the tyre's **transfer function**.



The **transfer function** represents the $\frac{\text{tyre response}}{\text{excitation}}$ ratio as a function of frequency.

Measurements may also be taken for other **boundary conditions**, such as when the tyre is not compressed or when the wheel centre is allowed to rotate freely. While the mode shapes do not vary greatly for different boundary conditions, the frequencies corresponding to each mode shape and the damping characteristics are slightly different. When rolling, the frequencies corresponding to each mode decrease by about 7 to 10 Hz.

Demonstration of a tyre's natural modes

Example for longitudinal excitation

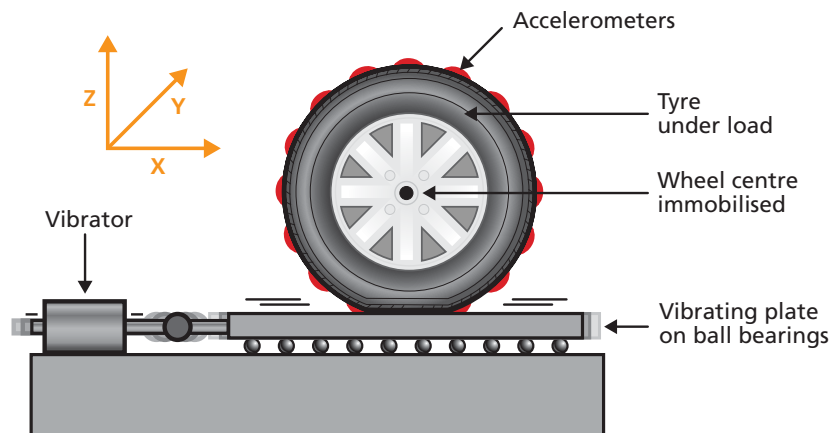

Tyre transfer function

Example for longitudinal excitation

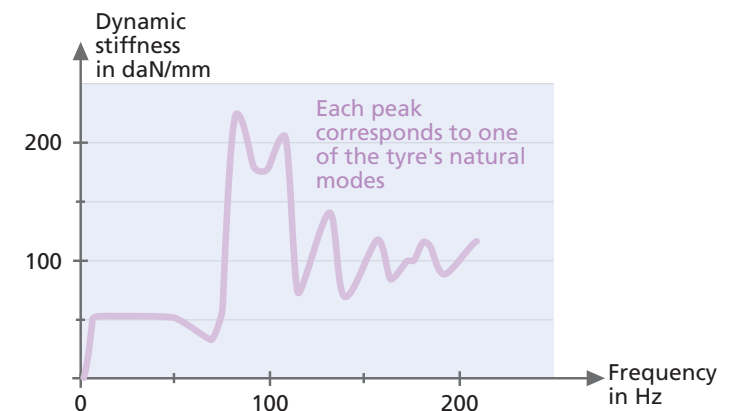

The ratio $\frac{\text{tyre response}}{\text{excitation}}$ expresses the **dynamic stiffness** of the tyre.

In this case, the excitation corresponds to the amount the plate is moved (in mm), and the tyre response is the force transmitted and recorded at the wheel centre (in daN).

■ RADIAL MODES

Radial vibration modes have a radial **distortion** pattern.

Examples of radial modes for a passenger car tyre at different frequencies

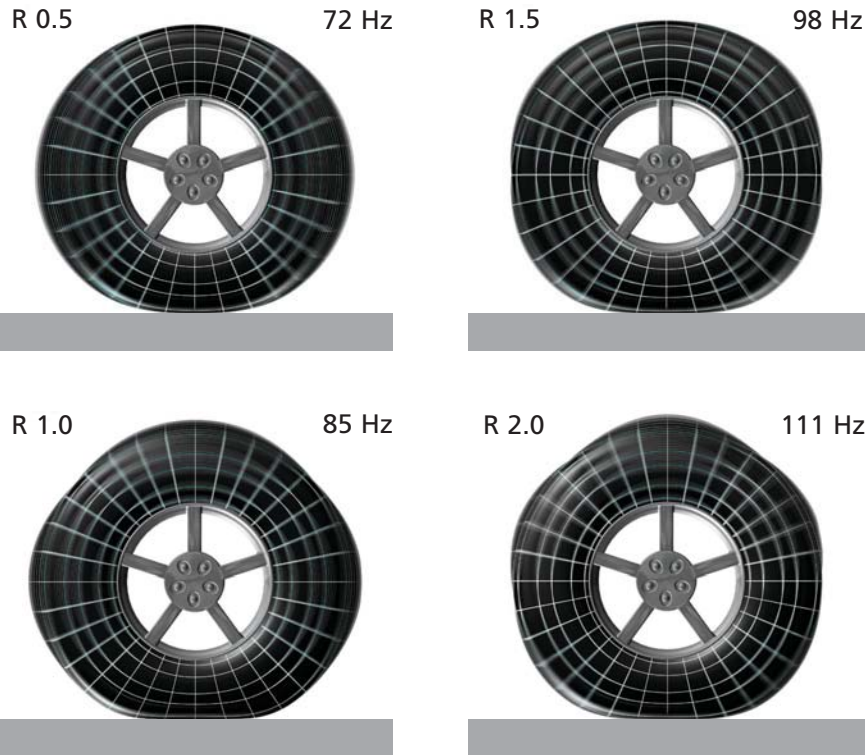

Boundary conditions: fixed wheel centre and loaded tyre (fixed contact patch).

■ TRANSVERSAL MODES

Transversal vibration modes have a transversal **distortion** pattern.

Examples of transversal modes for a passenger car tyre at different frequencies

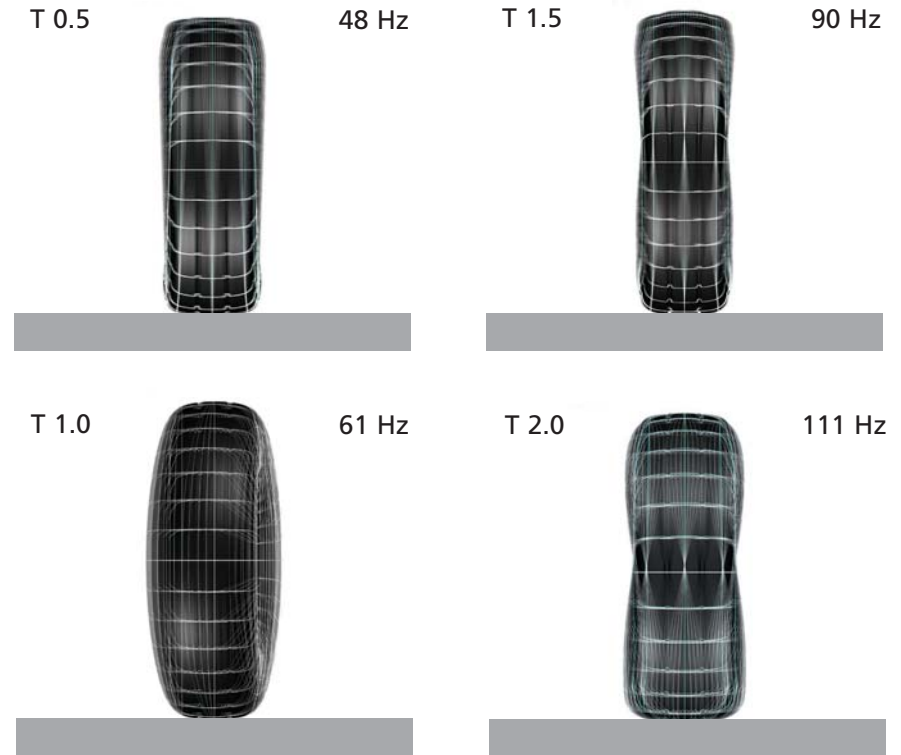

NB:

these distortions are practically IMPERCEPTIBLE TO THE NAKED EYE. They have been exaggerated in these illustrations to facilitate comprehension. When rolling, the distortion remains below one millimetre.

■ INTEGER MODES AND SEMI-INTEGER MODES

The tyre's natural modes, whether radial or transversal, are said to be integer modes if the distortion includes an even number of nodes, and semi-integer modes if the distortion has an odd number of nodes.

R n.0 ; R n.5 ; T n.0 ; T n.5 *

R for radial,
T for transversal

number of nodes divided by 2
n.0: integer mode
n.5: semi-integer mode

Note:

by convention, the contact patch is not counted as a node for radial modes, whereas it is for transversal modes.

The frequency of each natural mode varies from one tyre to another, depending on its dimension, mass and stiffness. The tyre's construction therefore determines its natural frequencies.



Simplified representation of tyre mode shapes

— extreme position 1
— extreme position 2

Semi-integer radial modes
R n.5

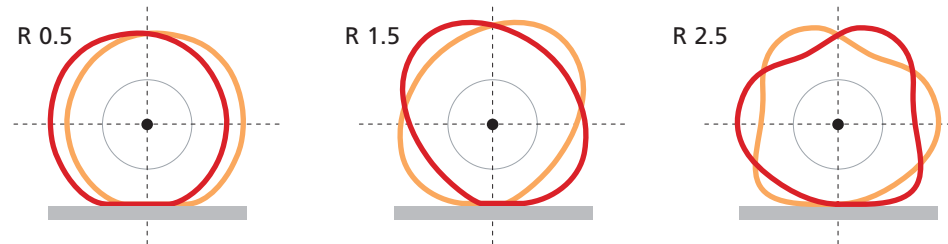

Integer radial modes
R n.0

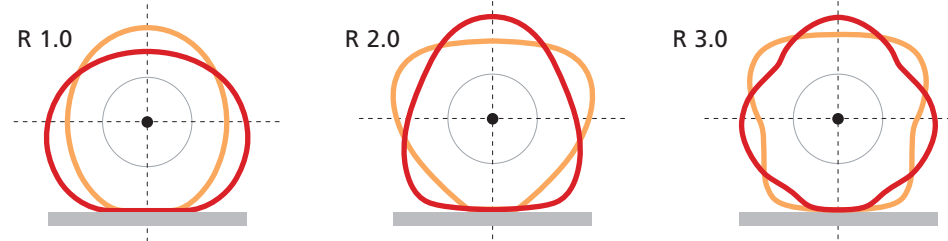

Semi-integer transversal modes
T n.5

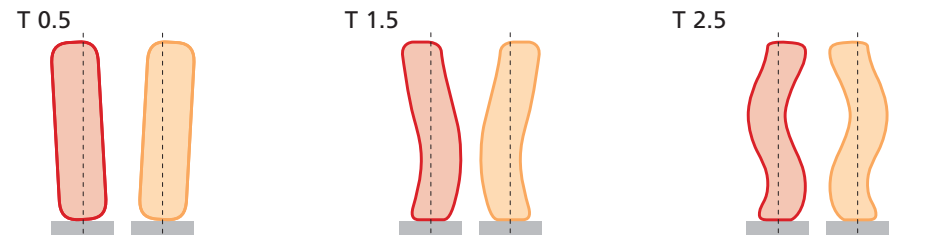

Integer transversal modes
T n.0

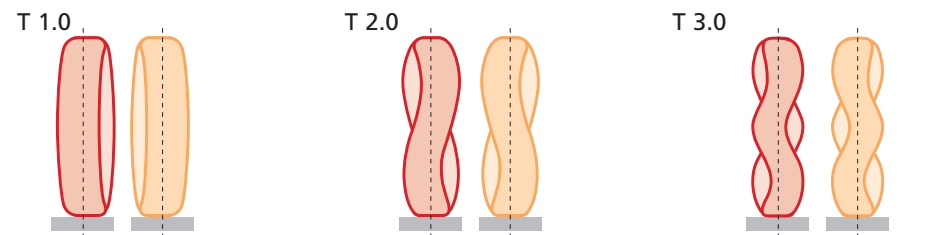

* In the U.S.A., another classification is used.

Table of integer and semi-integer modes

	Number of nodes divided by 2	Name	Type of excitation
Radial	Semi-integer	R n.5	X translation excitation
	Integer	R n.0	Z translation excitation
Transversal	Semi-integer	T n.5	Y translation excitation
	Integer	T n.0	(OZ) rotation excitation

Determining tyre modes from transfer functions

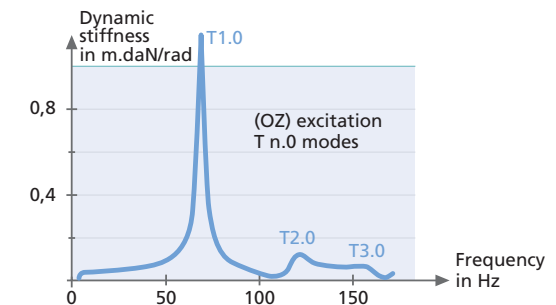
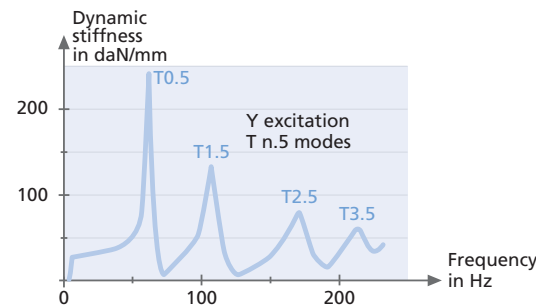
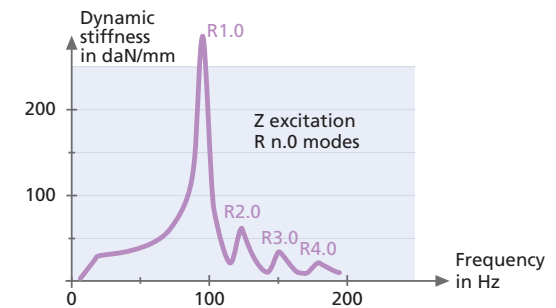
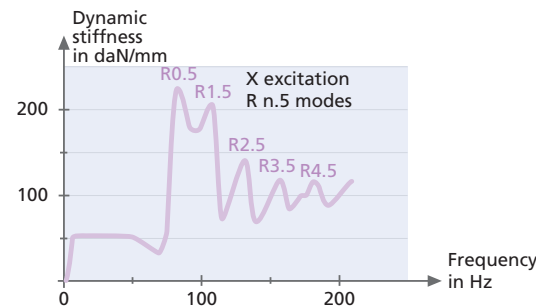

NB **Static stiffness** is the ratio of force over displacement for a non rolling tyre subjected to permanent compression. **Dynamic stiffness** is the ratio of force over displacement as a function of frequency for a rolling or non rolling tyre subjected to a vibratory excitation. Generally, dynamic stiffness is 10 to 15 times greater than its static stiffness. In the examples opposite, dynamic stiffness reaches 275 daN/mm whereas static stiffness remains around 25 daN/mm for a passenger car tyre.



Zoom on the T 2.0 transversal mode

The picture opposite shows the mode shape of a tyre represented as a "standing image". This is what an observer would see if the distortions were large enough to be visible to the naked eye. In this picture, all of the successive positions of the tyres are superimposed.

As it vibrates, the tyre changes position successively, as shown below. In the middle, the distortion is zero: this is the position of equilibrium. On each side, two different stages of distortion are shown.

NB:

these distortions are practically IMPERCEPTIBLE TO THE NAKED EYE. They have been exaggerated in these illustrations to facilitate comprehension. When rolling, the distortion remains below one millimetre.

The mode shape

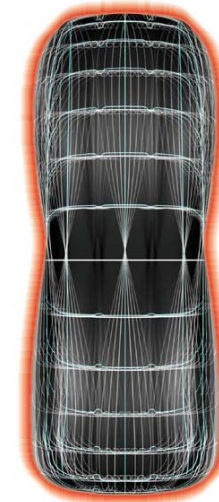

Breakdown of torsion movements



III.3.3

Above 250 hertz: vibrations in front of and behind the contact patch

MEASURING TYRE RESPONSE

The tyre is loaded in a stationary state to simplify operating conditions, then excited by means of a vibrator near the boundary of the contact patch. Lasers are used to measure the vibration speeds on the tyre's surface.

The measurements show:

- that there is a maximum vibration zone very close to the contact patch boundary;
- that vibration speed rapidly decreases as the distance from the contact patch increases.



At these frequencies, damping is greater than at lower frequencies. Due to their visco-elastic properties, the various rubbers in the tyre quickly damp the vibrations which cannot then propagate all around it. The tyre vibrates mainly in front of and behind the contact patch. The forces transmitted to the wheel centre are slight. The tyre's surface vibrations, on the other hand, can propagate to the surrounding air. This generates noise, as discussed in the next section.

Measuring tyre response above 250 Hz

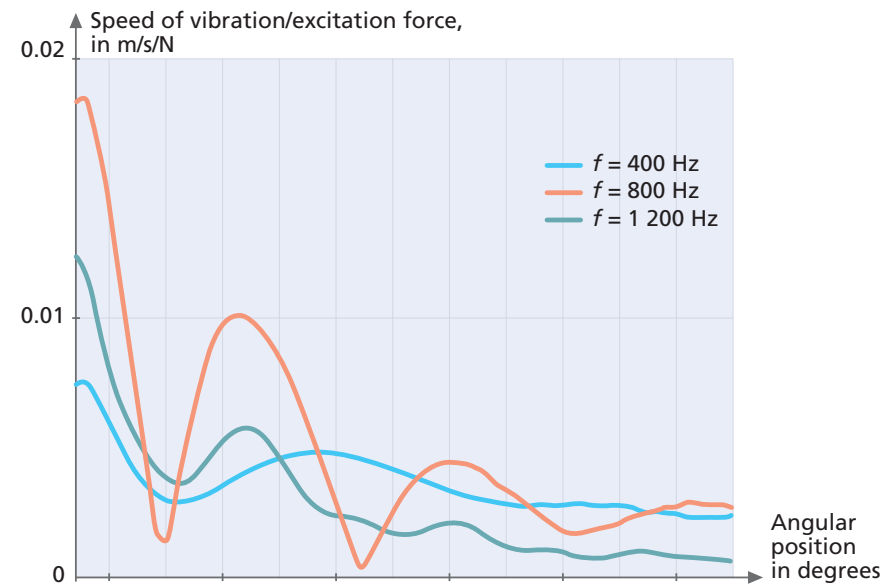
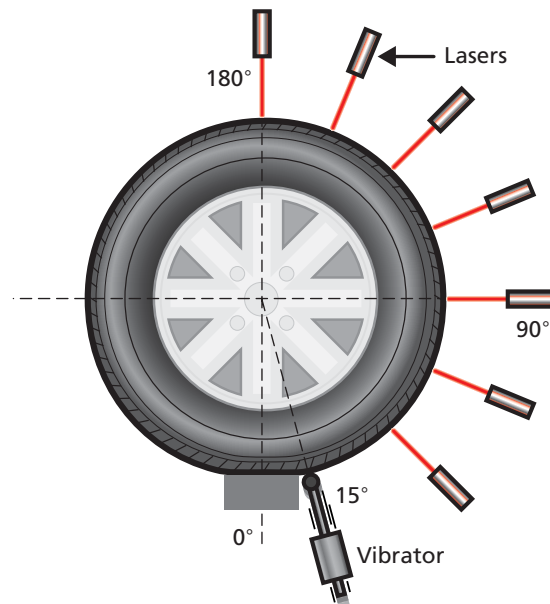

III.4

Propagation paths

When an object vibrates, it can transmit its vibrations to structures in contact with it. The vibration is then said to be **propagated through a structure**. The vibrating object may also make the surrounding air vibrate. This is known as **airborne propagation**.

The vibrations caused by the contact between the tyre and the road surface may thus follow two propagation paths towards passengers and people nearby.

Assuming a vibration's magnitude and frequency lie within the range of human perception, it can be felt by the person as a **mechanical vibration**. Again, assuming the vibration's magnitude and frequency lie within the range of human perception, it can be felt by the eardrum as an **auditory sensation**.

■ STRUCTURE-BORNE PROPAGATION TOWARDS PASSENGERS

Tyre vibrations may be propagated via the suspension and steering system to the rest of the car. Inside the car, these may be felt in two ways:

- as a mechanical vibration, via the floor, the seat or the steering wheel;
- acoustically, when surfaces vibrating inside the vehicle transmit the vibrations to the air (in this case propagation is first structure-borne and then airborne).

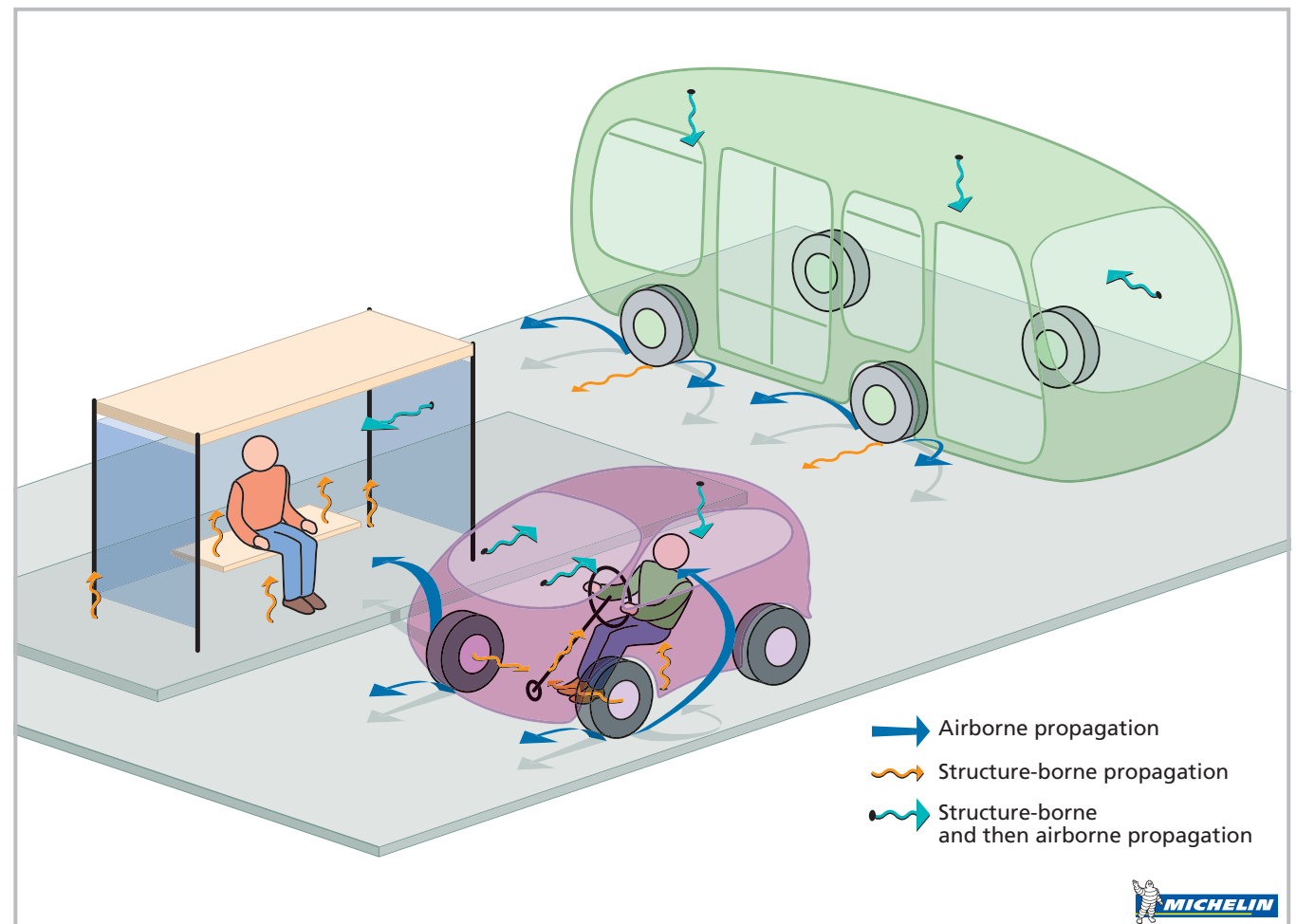

■ STRUCTURE-BORNE PROPAGATION TOWARDS NEARBY PEOPLE

Tyre vibrations are transmitted to the road surface, then to buildings. There, they may be felt in the form of mechanical or acoustic vibrations. However, tyres considerably reduce this kind of vibration. Consider the underground for example. Vibrations caused by the passage of an underground train carriage without tyres are felt up to the top floors of surrounding buildings. If the carriage is fitted with tyres, the vibrations are scarcely perceptible.

Frequencies below 800 Hz may be propagated through structures.

■ AIRBORNE PROPAGATION TOWARDS PASSENGERS AND NEARBY PEOPLE

Tyre surface vibrations cause the surrounding air molecules to vibrate. The outside air then transmits its energy to the air inside the vehicle or buildings, in particular by making panes of glass vibrate.

Frequencies above 800 Hz may be propagated through air.

• Summary

Propagation  towards	Eardrum	Body
Airborne	Perception of noise	...
Structure-borne	...	Perception of vibrations
Structure-borne then airborne	Perception of noise	...

Structure-borne propagation of noise

The concept that noise can be propagated through solids may at first seem surprising. To understand it better, consider the example of a drill in a block of flats. Somebody on the first floor drills a hole. Four floors higher, the noise is as loud as if someone were drilling through the wall next door. It has been shown that noise transmitted by the air from a point source decreases by 6 dB whenever the distance is doubled. So why is the drill heard so clearly? Because the vibrations producing the noise are being propagated through the walls up to the fourth floor, with very little energy loss.

Then the walls in turn make the air inside the flat vibrate, thus producing a sound. **The noise is first propagated through a structure and then through the air.**

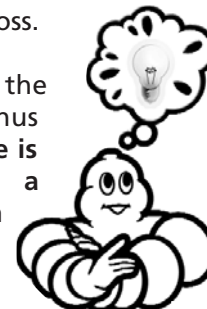

Frequency ranges of structure-borne and airborne propagation

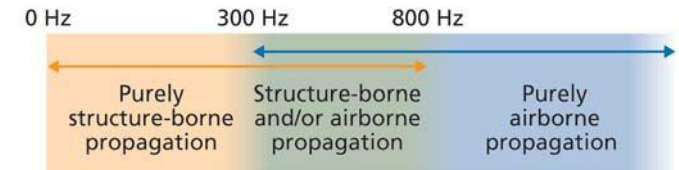

III The tyre: a vibration filter

FROM CAUSE TO DISTURBANCE

EXCITATION
by the road surface
and tyre tread pattern



FILTER 1
Vibratory behaviour
of the tyre

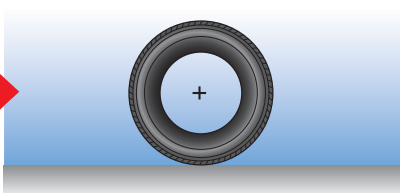

FILTER 2
Vibratory behaviour
of the vehicle

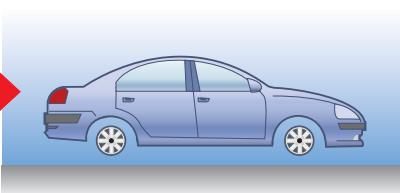

FILTER 3
Range of human
sensitivity



Comfort
or
discomfort

Outside its natural frequencies, the tyre filters vibrations.
At its natural frequencies, it amplifies them.

Outside its natural frequencies, the vehicle filters vibrations.
At its natural frequencies, it amplifies them.

Passengers feel discomfort if the frequency and magnitude of the vibrations reaching them fall within their range of perception.

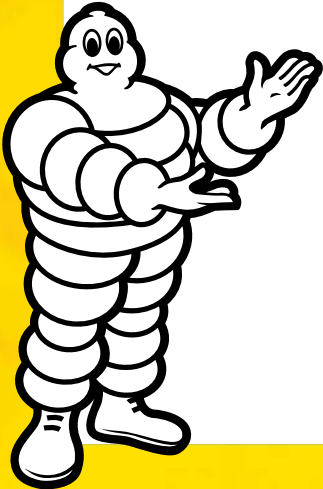

III The tyre: a vibration filter

When rolling, the road surface and tread pattern excite the tyre over a wide frequency range.

The tyre transmits part of this excitation to the vehicle. Depending on the frequency, the tyre can filter and dampen the vibrations or amplify them.

To understand the role of tyres in mechanical and acoustic comfort, it is necessary to understand the vibratory behaviour of the tyre throughout this frequency range.

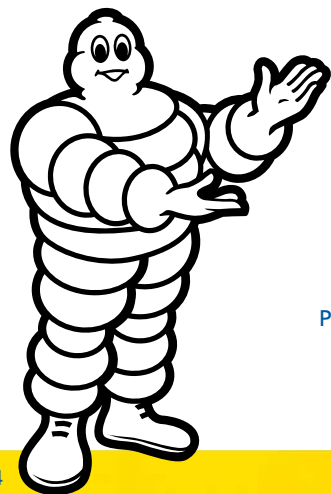
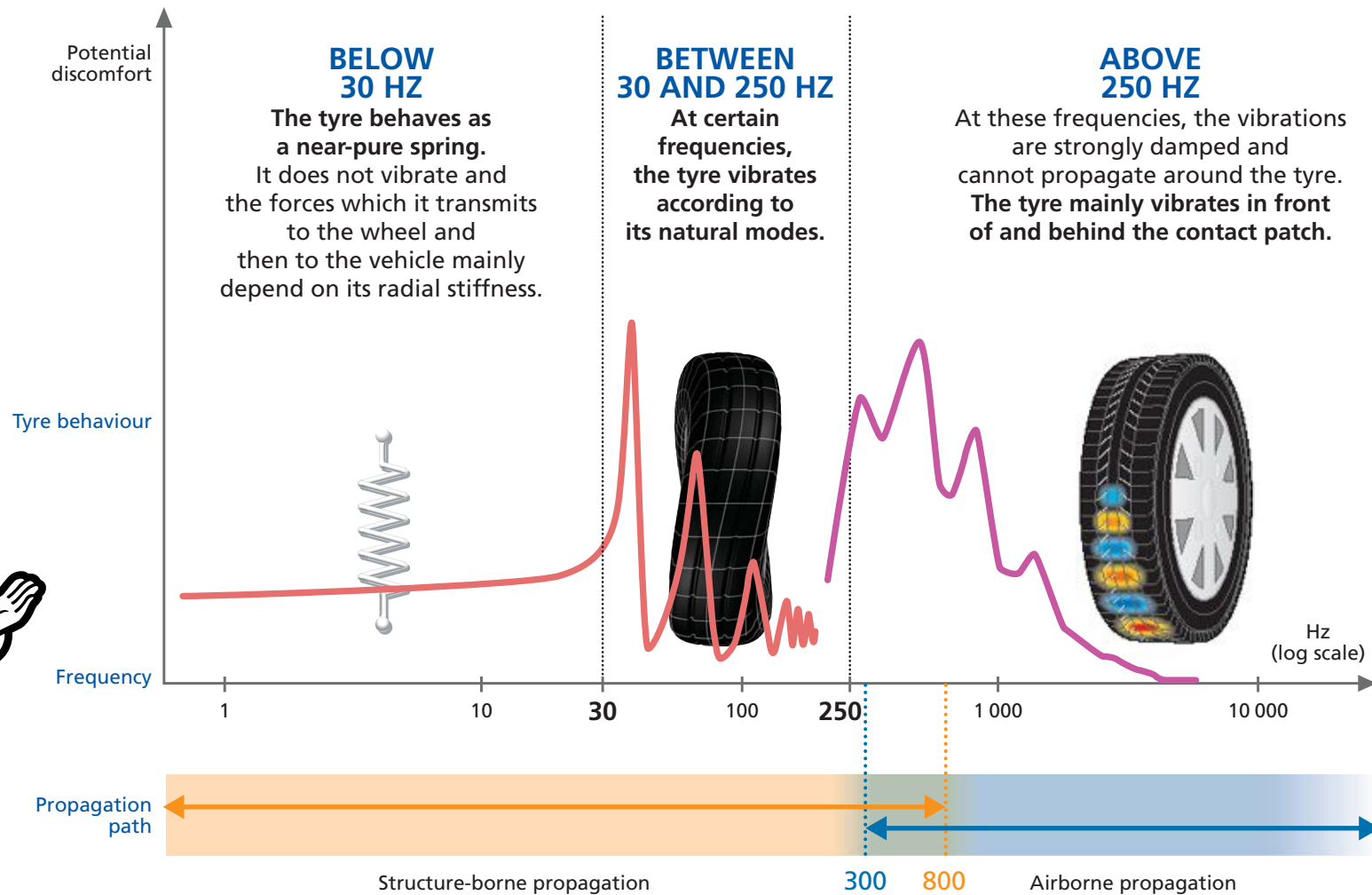



IV *Mechanisms leading to vibratory disturbance*

Tyre comfort refers to the tyre's capacity to absorb road surface irregularities and filter mechanical vibrations affecting passengers and local residents.

This chapter investigates the possible causes of vibratory disturbance and the role played by tyres in each case.

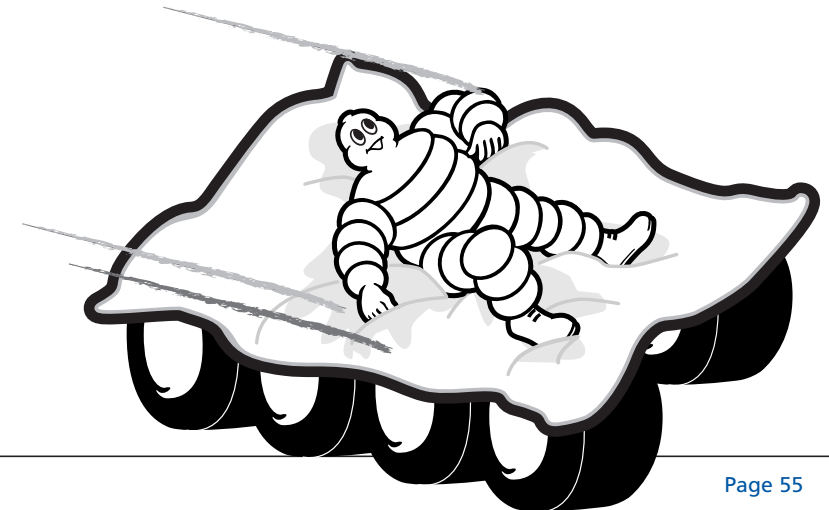

IV.1

Jolting on bumpy roads

The jolting experienced on bumpy roads is due to longitudinal irregularities between 50 centimetres and 50 metres in length and from a few millimetres to a few centimetres high.

This type of irregularity is called **unevenness**. In Western Europe, it is mainly found on secondary roads.

Inside the car, the driver and passengers perceive jolts through the floor, seat and steering wheel. The strength of these accelerations depends on the tyres and the suspension and is known as **hardness**. The time the accelerations take to die down also varies according to the tyres and suspension and is known as the **damping time**.

0.1 and 60 Hz. However, at the most common speeds for a car driving on a secondary road (about 80 km/h) and for the most frequent wavelengths encountered on this type of road, most of the vibratory energy will lie below 30 Hz.

For slower types of vehicle such as earthmovers or farm vehicles, the most common excitation frequencies are more likely to lie between 1 and 20 Hz.

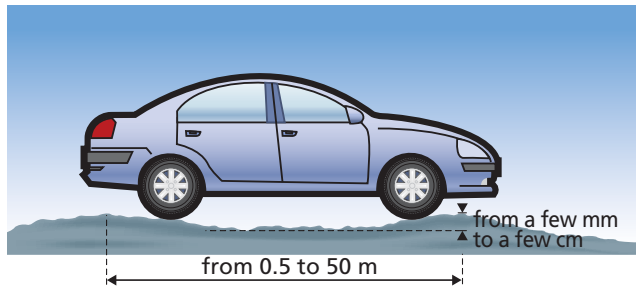

■ EXCITATION FREQUENCIES

For a vehicle driving at between 20 and 110 km/h on a road with longitudinal unevenness of wavelengths between 0.5 and 50 m, the theoretical frequencies of the vibrations may lie between

Excitation frequencies (in Hz) generated by longitudinal unevenness of a road as a function of length of the irregularities and speed

Speed		Wavelength (m)										
(km/h)	(m/s)	0.5	1	2	3	4	5	10	20	30	40	50
18	5	10	5	2.5	1.67	1.25	1	0.5	0.25	0.17	0.13	0.1
36	10	20	10	5	3.33	2.5	2	1	0.5	0.33	0.25	0.2
54	15	30	15	7.5	5	3.75	3	1.5	0.75	0.5	0.38	0.3
72	20	40	20	10	6.67	5	4	2	1	0.67	0.5	0.4
80	22.2	44.4	22.2	11.1	7.4	5.55	4.44	2.22	1.11	0.74	0.56	0.44
90	25	50	25	12.5	8.33	6.25	5	2.5	1.25	0.83	0.63	0.5
108	30	60	30	15	10	7.5	6	3	1.5	1	0.75	0.6

Most powerful frequencies for earthmovers or farm vehicles

Most powerful frequencies on secondary roads

Frequencies likely to cause motion sickness

Vertical vibrations recorded at floor level

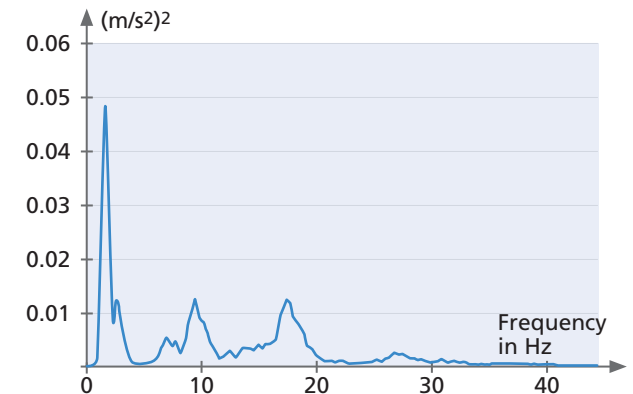

NATURAL MODES OF VEHICLES WITH SUSPENSION

The vibration of a vehicle with a suspension may be shown as follows (the representation is known as a 'quarter-car model'):

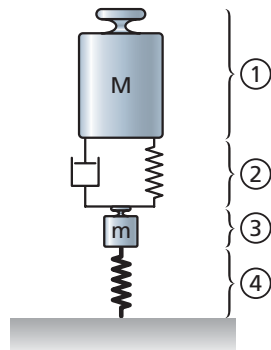

- ① = Mass M representing 1/4 of the **sprung masses** of the vehicle (in other words, the masses supported by the suspension: the whole vehicle less the tyre/wheel assemblies and suspension rods). The movements of sprung masses are commonly known as **rigid-body motions**.
- ② = "Spring + viscous shock absorber" system representing the vertical stiffness and shock absorbing capacity of the **suspension**.
- ③ = Mass m representing 1/4 of the **unsprung masses** (tyre/wheel assemblies + suspension rods + hubs + brakes).
- ④ = Spring representing the vertical stiffness of the **tyre**.

The system's behaviour depends on the frequency.

Between 0 and 10 Hz, excitation causes the car body to move up and down but does not affect the unsprung masses. On a real vehicle, as there are two axles, there are two types of rigid-body motions: **bouncing** and **pitching** (see following page).

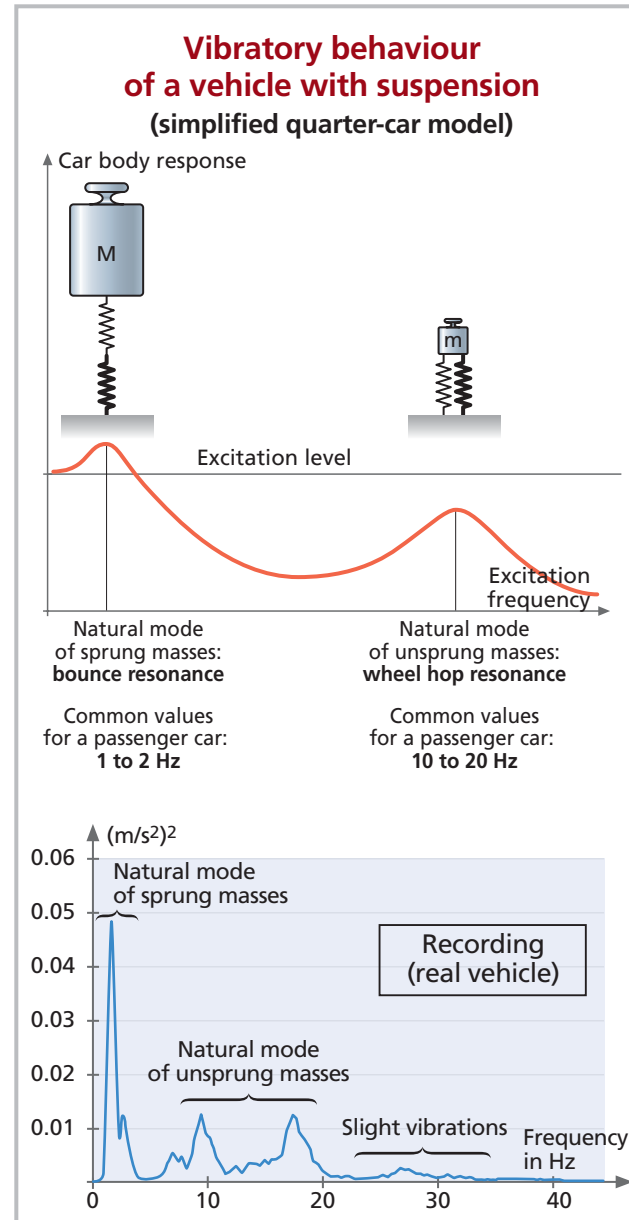

The natural frequency of sprung masses lies around 1.5 Hz. At this frequency, the vehicle car body will oscillate strongly: this is known as **rigid-body resonance** or **bounce resonance**.

Between 10 and 20 Hz, excitation mainly affects the unsprung masses, whose natural frequency lies within this band. Tyre/wheel assemblies oscillate vertically between the road and the vehicle body: this is known as **wheel hop** (sometimes called wheel rebound). The movement of unsprung masses also causes jolting inside the car.

On a real vehicle, although the excitation frequencies are the same for both front and rear axles, the excitation affects the rear axle later. This delay (Δt) depends on the vehicle's wheelbase and the driving speed*. The measurements recorded in a real situation inside the car show a twin peak for wheel hop resonance.

Between 20 and 30 Hz, the simplified system does not have any natural modes. The real vehicle shows distortion modes for its component parts. Inside the car, passengers may feel small vibrations.

* $\Delta t = \frac{L}{V}$ where L is the vehicle wheelbase and V the velocity



Pitching and bouncing

Pitching

Pitching is an oscillating movement from front to rear. It should not be confused with rolling, which is an oscillating movement from right to left.*

A car pitches if the wavelengths of road unevenness are such that the vertical movements of the front and rear are in **phase opposition**, in other words, if the front axle drops into a depression while the rear moves up onto a bump, or vice versa.

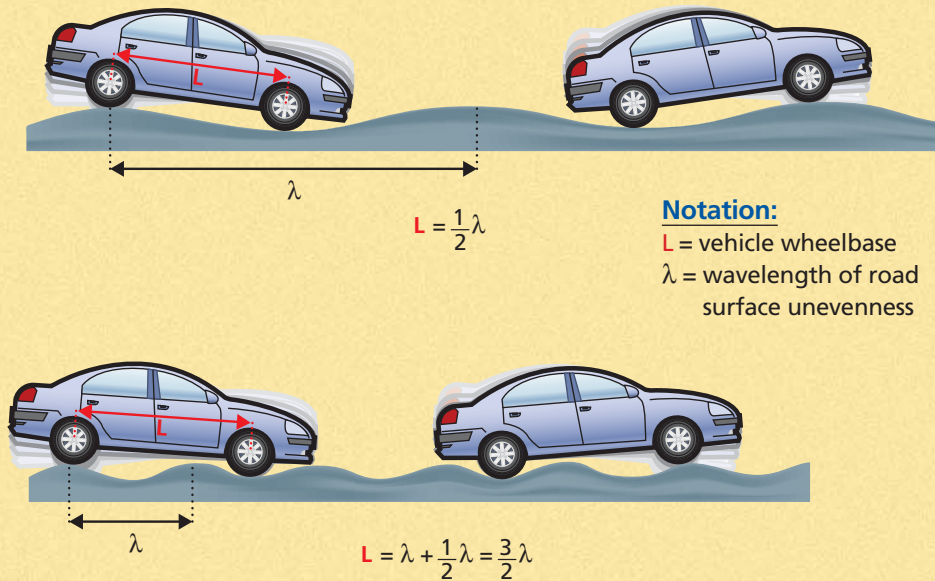

Notation:
 L = vehicle wheelbase
 λ = wavelength of road surface unevenness

Pitching is likely to occur when the vehicle wheelbase (L) is an odd multiple of half the wavelength ($\frac{\lambda}{2}$) of the road surface unevenness, in other words, if $L = (2n + 1) \frac{\lambda}{2}$ where n is a whole number greater than or equal to 0

* Rolling is not addressed in road comfort research as the road infrastructure has very few transversal irregularities.

Bouncing

Bouncing is an up and down oscillating movement of the vehicle.

Bouncing occurs if the vertical movements of the front and rear are **in phase**, in other words, if the front and rear axles are both in a depression or both on a bump at the same time. In this case, the front and rear of the vehicle rise or fall together.

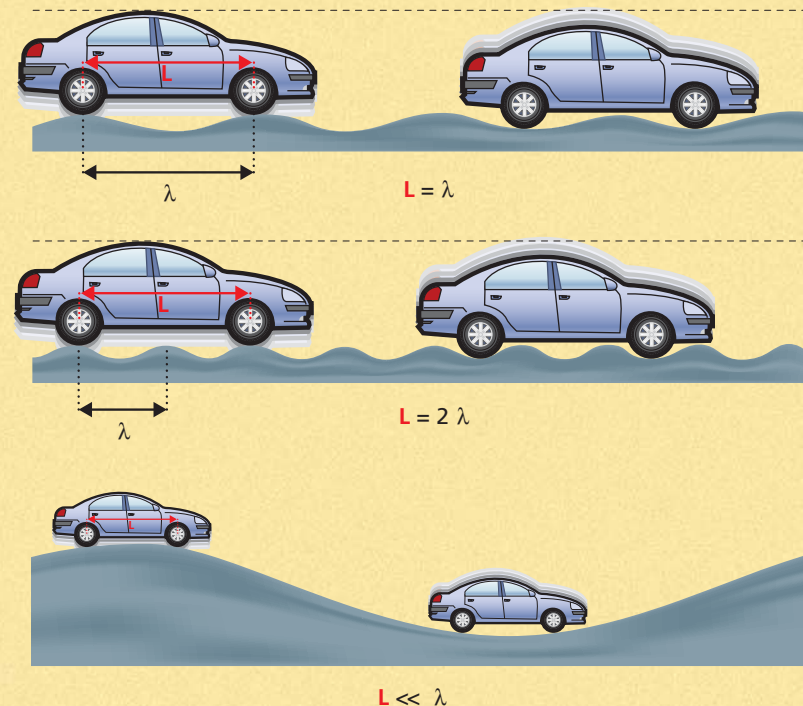

Bouncing is likely to occur when the vehicle wheelbase (L) is a multiple of the wavelength of the road surface unevenness or if they are much longer than the vehicle's wheelbase, in other words, if $L = n \cdot \lambda$ where n is a whole number greater than or equal to 0 or if the speed is high and $L \ll \lambda$.

Pitching and bouncing (continued)



Bouncing is perceived in the same way wherever the passenger is sitting, as the front and rear rise and fall at the same time. On the other hand, when a car **itches**, the further the passengers are sitting from the pivotal point, the more they will feel the accelerations.

A car's geometrical design is such that the front seats are closer to the pivotal point than the rear seats. Rear-seat passengers are thus subjected to stronger pitching accelerations than front-seat passengers. This difference is even more marked if the vehicle has a long wheelbase, like a minivan.

Combined bouncing and pitching on the road

In reality, bouncing and pitching phenomena coexist. This is because roads are never uniformly regular. Their unevenness varies in length more or less randomly and, if driven over in quick succession, cause almost simultaneous bouncing and pitching. The closer the excitation frequencies are to the vehicle's natural frequencies, the greater the jolting felt within the vehicle.

Effect of pitching in the front and rear

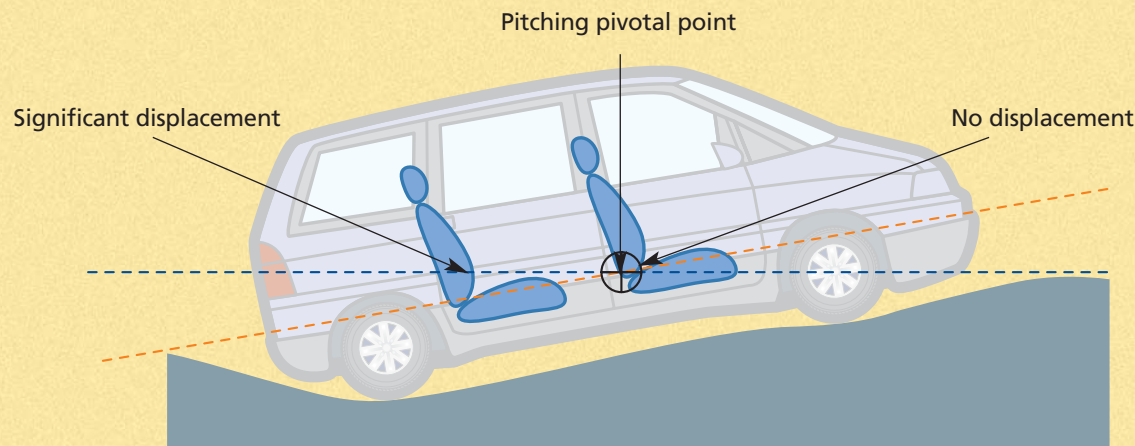

- At the rotation pivotal point, the vertical movements and vertical acceleration are nil (within the vehicle's reference framework).
- The rear seat is further from its initial horizontal position than the front seat. It has thus been subjected to a greater vertical acceleration.

■ EFFECT OF TYRES ON VIBRATION LEVELS

Tyres do not have any natural modes between 0 and 30 Hz. Within this frequency range, the magnitude of the forces that a tyre transmits to a wheel and then to the vehicle depends directly on its radial stiffness.

Radial stiffness also affects the frequency of the sprung and unsprung masses (see following page). However, in practical terms, the scope of a tyre engineer is limited when it comes to radial stiffness.

Test drivers have observed that the tyre also affects the **damping time** of the car body and tyre/wheel assembly oscillations. This is due to the visco-elastic properties of elastomers. Investigators are currently characterising the mechanisms behind these phenomena.

A little more information on...



... the natural frequency of sprung and unsprung masses

The frequency of a mass and spring system is equal to: $f = \frac{1}{2\pi} \sqrt{\frac{K}{M}}$

where K is the spring stiffness
and M the mass

■ "Addition" principle applied to spring stiffness

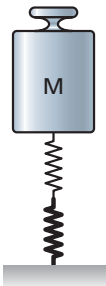

When considering the natural mode of sprung masses, the "suspension" and "tyre" springs are placed in series in relation to the mass. According to the addition principle applied to the stiffness of springs in series, the total stiffness, K_t , is equal to:

$$K_{t \text{ sprung mass}} = \frac{K_{\text{suspension}} \cdot K_{\text{tyre}}}{K_{\text{suspension}} + K_{\text{tyre}}}$$

■ Calculation of natural frequencies

Orders of magnitude for a quarter-car model (passenger car):

$M = 250 \text{ kg}$, $m = 30 \text{ kg}$,
 $K_{\text{suspension}} = 25\,000 \text{ N/m}$,
 $K_{\text{tyre}} = 175\,000 \text{ N/m}$.

Therefore:

$$K_{t \text{ sprung mass}} = 22\,000 \text{ N/m}$$

$$f_{\text{sprung mass}} = 1.5 \text{ Hz}$$

and

$$K_{t \text{ unsprung mass}} = 200\,000 \text{ N/m}$$

$$f_{\text{unsprung mass}} = 13 \text{ Hz}$$

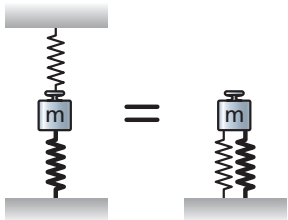

When considering the natural mode of unsprung masses, the "suspension" and "tyre" springs are placed in parallel in relation to the mass. According to the addition principle applied to the stiffness of springs in parallel, the total stiffness, K_t , is equal to:

$$K_{t \text{ unsprung mass}} = K_{\text{suspension}} + K_{\text{tyre}}$$

IV.2

Impacts due to isolated obstacles

Tyres may be subject to shocks due to isolated obstacles such as road surface joints, speed bumps, manhole covers, bridge joints or small potholes.

These obstacles, between 5 and 30 mm high and a few mm to a few cm long, may protrude above or be a break in the road surface.

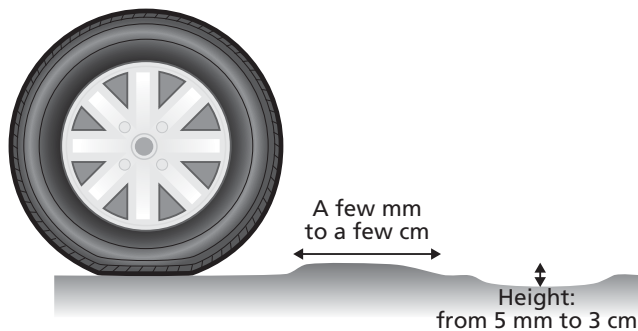

Inside the vehicle, the driver and passengers feel the **shocks**, which cause multi-frequency excitation leading to mechanical and acoustic vibrations with **frequencies between 0 and 200 Hz**. These accelerations may be felt to a greater or lesser extent and appear to last longer or shorter depending on the type of tyre fitted. This is referred to as **impact harshness**. When travelling slowly, each axle may be felt going over the obstacle, whereas at higher speeds, the two shocks appear to occur almost simultaneously.

THE MECHANISM

To clarify the phenomenon, let us consider a tyre rolling **very slowly** over a rectangular bar.

The tyre mounts the obstacle and is distorted by it (2), then envelops it without perfectly matching its contour (3). It then "descends" on the other side (4).

As the tyre rolls over the obstacle, the wheel centre is subjected to vertical loads (along the Z axis) and longitudinal loads (along the X axis).

When recorded, the forces exerted along the X axis produce a sinusoidal signal, whereas along the Z axis, the signal resembles the two humps of a camel.

As the tyre rolls over the obstacle, two successive responses may be observed:

- a **forced response**, which corresponds to the tyre's distortion caused by the obstacle;
- a **free response**, which corresponds to the tyre's vibrations following excitation. The magnitude of the free response depends on that of the forced response.

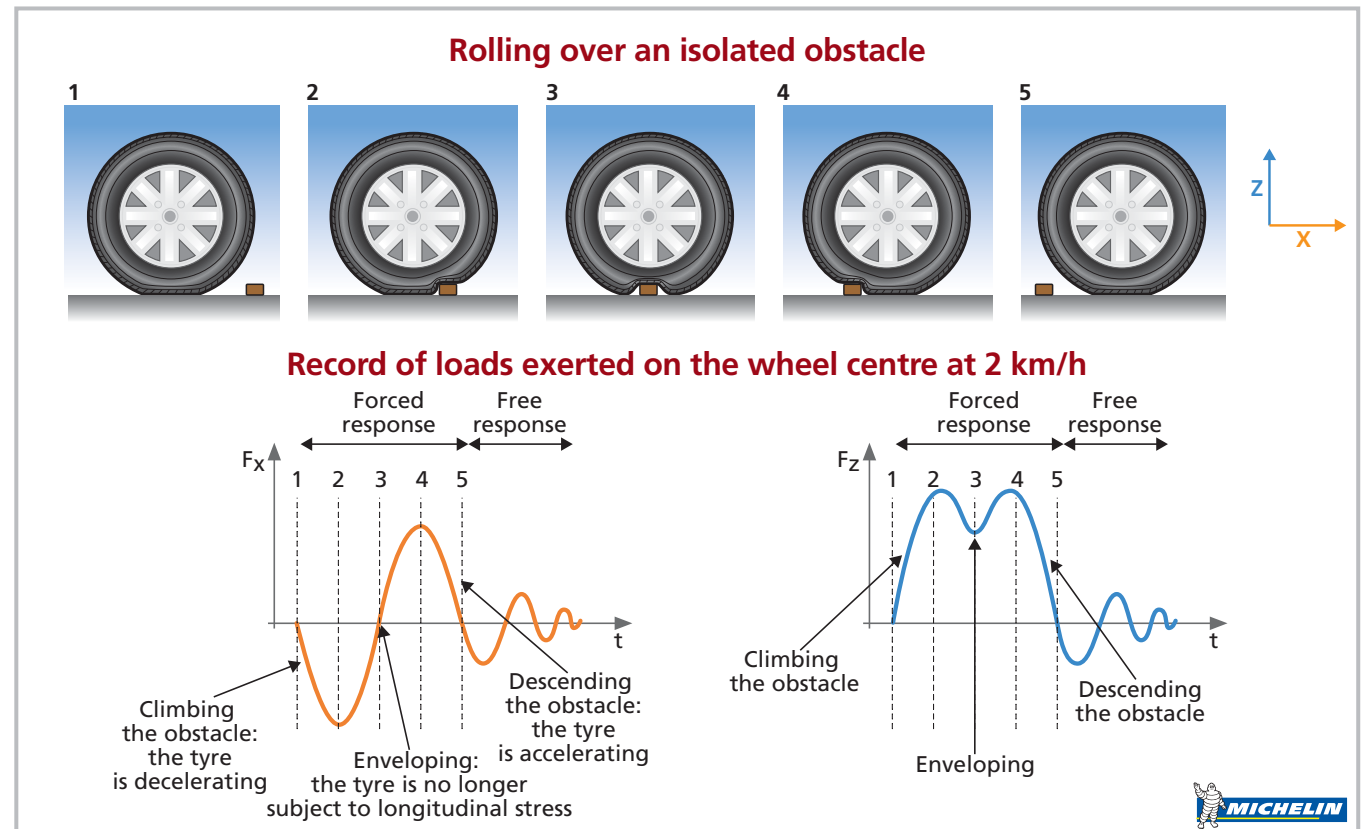

■ THE FORCED RESPONSE

Because it can be deformed, the tyre can "absorb" the obstacle, in other words, it can envelop the obstacle, thus limiting wheel centre movements and preventing the wheel from bouncing once it has cleared the obstacle.



Let us compare how a wheel without a tyre and a wheel fitted with a tyre roll over an obstacle (see box).

The tyre acts as a spring which compensates for the height difference when clearing the obstacle. The wheel centre lifts only slightly if at all. It undergoes almost no displacement but mainly forces which are in direct proportion to the tyre's radial stiffness.

Wheel without tyre: the wheel lifts up when rolling over the obstacle then bounces.

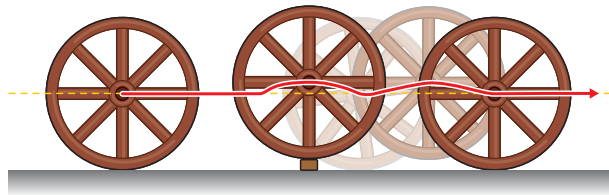

Wheel fitted with tyre: the tyre "absorbs" the obstacle. The wheel does not lift up when rolling over the obstacle.

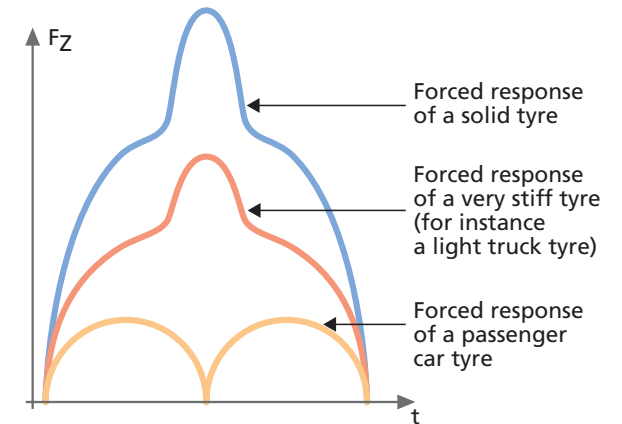
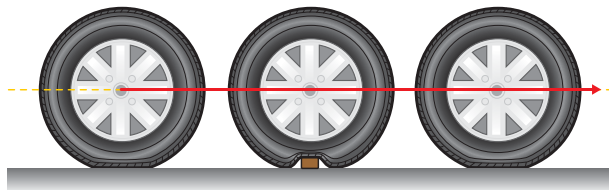

- The forced response depends on tyre stiffness and the shape of the obstacle.
- $F_z \approx 20\%$ of the tyre load for an obstacle of 1×2 cm.
- Generally speaking, about 25% of a passenger car tyre's stiffness is due to its design (construction and materials) and 75% to its inflation pressure.



The tyre "absorbs" shocks

In 1920, researchers demonstrated that pneumatic tyres were far superior to solid tyres.

Experimental conditions:

Truck tyre clearing a 15 mm high obstacle at 20 km/h.

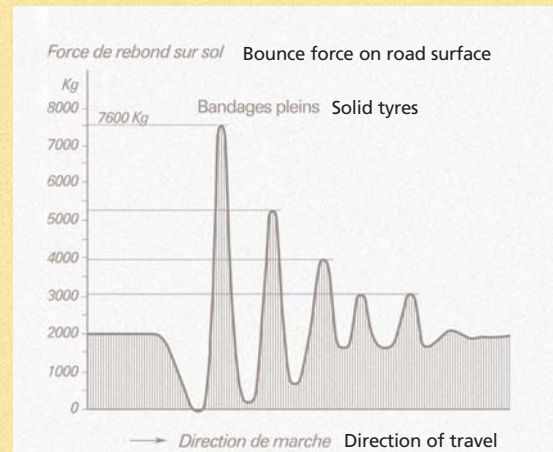

Bounce overload: +280% (3 g)

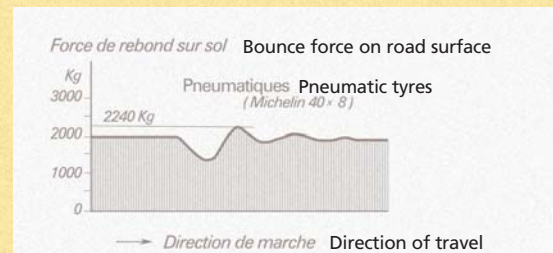

Bounce overload: +12% (0.12 g)

TYRE RESPONSE ON THE ROAD

There are two consecutive responses:

- when rolling over an obstacle, the tyre acts as a filter by minimising the load transmitted to the wheel centre;
- once the obstacle has been cleared, the tyre can become a source of excitation. It then vibrates according to its natural modes, restoring the energy stored when rolling over the obstacle.



Drum for measuring loads at the wheel centre. Here the tyre is rolling over a plate 5 mm thick and 60 cm long.

Tyre response

when rolling over a 60 cm long plate at 60 km/h

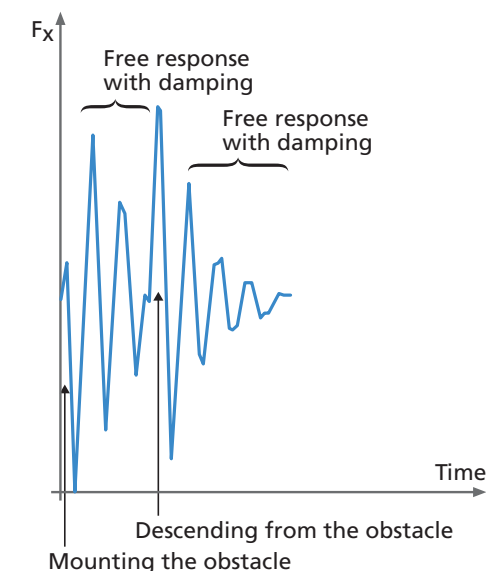
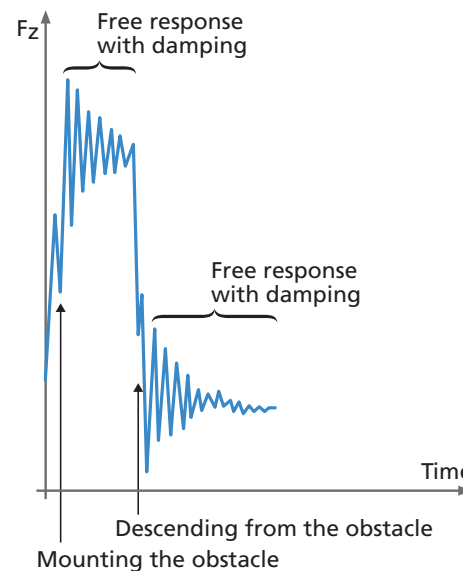

Rolling over an isolated obstacle can excite one or more of the tyre's natural modes, and primarily the first integer radial mode (along the Z axis) and the first four or five semi-integer radial modes (along the X axis). The excitation frequencies, which lie between 0 and 200 Hz, depend directly on the speed at which the obstacle is rolled over.

The tyre's vibrations generate loads which are first exerted on the wheel centre then transmitted to the car cabin, where they cause mechanical and acoustic vibrations. Since people feel mechanical vibrations more strongly at lower frequencies, the vibratory disturbance will be more apparent when travelling slowly. Between 0 and 200 Hz, however, human sensitivity to noise increases with frequency. High-speed travel will lead to mainly acoustic discomfort.

■ EFFECT OF TYRES ON VIBRATION LEVELS

 The mechanical comfort gained through tyre design and a judicious choice of component materials to decrease radial stiffness in particular, is around 10 to 15% in terms of a vibration index.

The vibrations actually perceived, however, strongly depend on the coupling between the tyre/wheel assembly and the vehicle.

Frequency spectrum of loads exerted on the wheel centre

when a tyre rolls over a 10 mm x 20 mm cleat

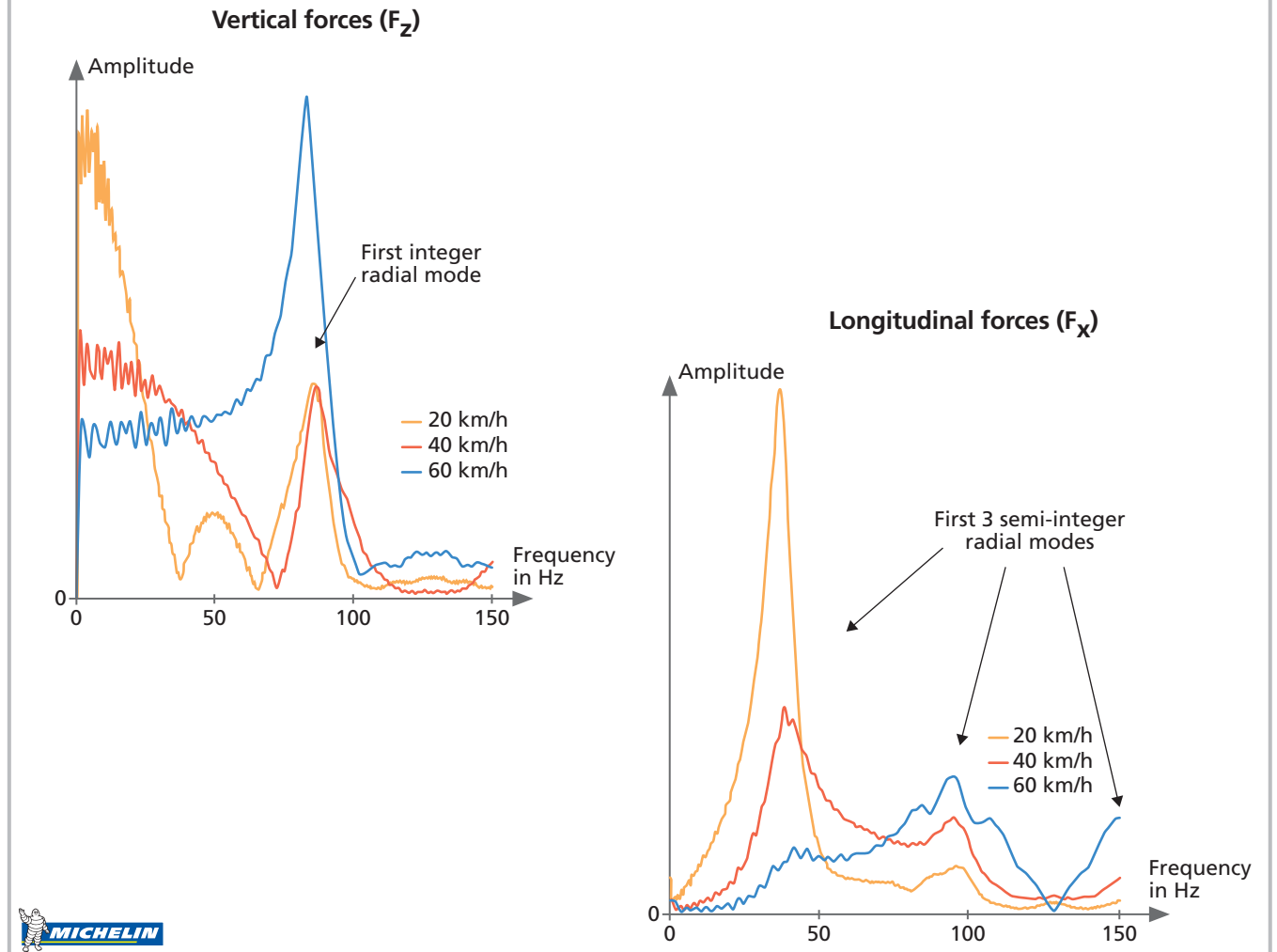

IV.3

The non-uniformities of tyre/wheel assemblies

Roads are not the only source of vibratory disturbance. The tyre and wheel, together known as a mounted assembly, can also be a source of vibration due to slight irregularities caused either during use or earlier, during manufacture or mounting, in spite of demanding tolerance specifications.

Irregularities may occur in shape, mass or stiffness. They are known as **non-uniformities**.

On the road, non-uniformities in shape, mass or stiffness all cause variations of forces at the wheel centre, possibly leading to vibrations.



■ MASS NON-UNIFORMITIES

Non-uniformities of mass, known as **imbalance**, correspond to an irregular distribution of tyre mass. They may be compared to small weights irregularly distributed inside the tyre tread, slightly offsetting the tyre's uniformity.

Imbalance is most often due to slight irregularities in tread thickness. It may also occur following harsh braking, leading to significant but locally limited worn patches.

Imbalance phenomena may be divided into two categories:

- static imbalance,
- dynamic torque (a.k.a dynamic couple).

Static imbalance may be observed without rotating the tyre (hence the name static). The mounted assembly is simply placed on an axle and, under the effect of gravity, the tyre turns around until the "excess" mass is at the bottom. When the tyre is rotated, centrifugal force locally increases the tyre radius (a deformation not always visible to the naked eye), thus causing **variations in radial forces** at the wheel centre and hence vertical and longitudinal vibrations.

Dynamic torque can only be observed when a tyre is rotated. This imbalance creates centrifugal forces offset from the tyre's median plane, leading to a **deflection torque**. This torque induces **variations in lateral forces** at the wheel centre, felt by the driver as transversal vibrations in the steering wheel. It should be noted that for a given value, the dynamic torque is generally felt less through the steering wheel than is the static imbalance.

On the road, the effects of static imbalance and dynamic torque are combined. We then refer to **dynamic imbalance**.

Imbalance phenomena are compensated for by **balancing** the mounted assemblies.

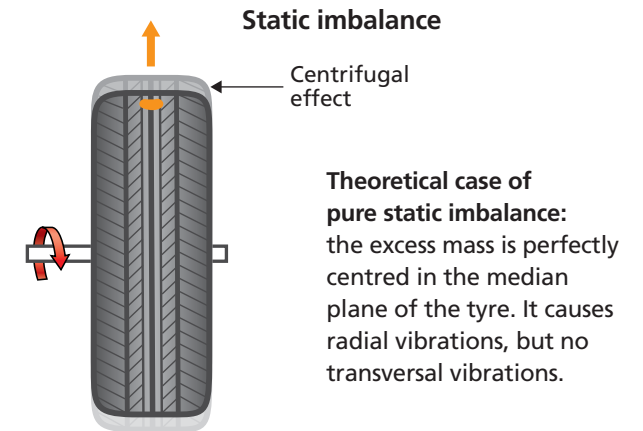

Weights representing mass irregularities

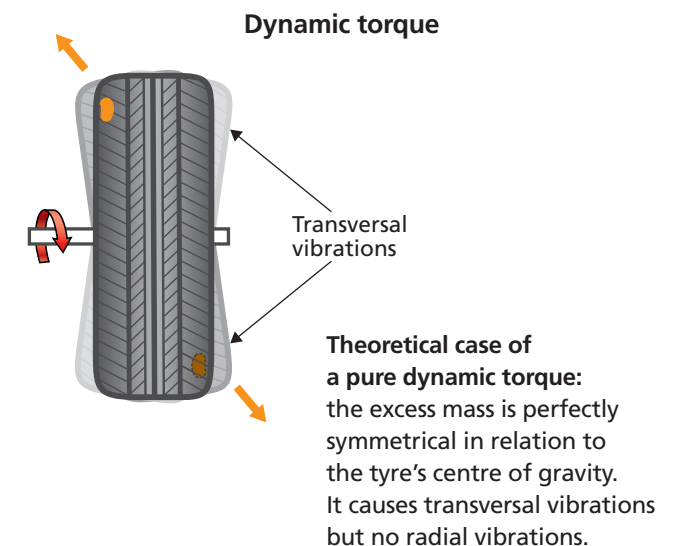



Wheel balancing



Balancing machine

A mounted wheel/tyre assembly may exhibit both a static imbalance and a dynamic torque. Balancing consists of compensating them by attaching compensating weights on each side of the wheel.

Step one: the balancing machine measures the force F_b created by the static imbalance at a given rotation speed and its angular position on the wheel. The machine then calculates the mass necessary to compensate this imbalance.

Mass calculation:

Force F_m created by a mass m hooked on the rim is equal to:

$$F_m = m \cdot \omega^2 \cdot R_j$$

where m is the weight mass,
 ω , the angular speed of the rotating assembly,
and R_j , the distance between the weight and the wheel centre, i.e. the wheel rim radius.

Mass m must thus be chosen such that:

$$F_b = F_m \quad \text{i.e.} \quad m = \frac{F_b}{\omega^2 \cdot R_j}$$

To avoid creating an interfering torque, this mass is divided into two equal weights that are attached to each side of the wheel at the same angular position.

Second step: the machine measures the deflection torque, its angular position and the mass needed to compensate this imbalance (calculation not given). In order not to create an interfering static imbalance, the mass is divided into two equal weights. One is attached on the inboard flange of the wheel at the angular position measured by the machine, and the other on the outboard flange diametrically opposite the inboard one.

Static imbalance and dynamic torque are thus balanced using four weights. The **final step** consists in calculating a vector sum to obtain a single resultant mass for each rim side and also its angular position.

■ SHAPE NON-UNIFORMITIES

There are two types of non-uniform shape:

- radial run-out,
- lateral run-out.

It should be remembered that non-uniformity tolerances during manufacture are small and rarely perceptible to the naked eye. On the other hand, those arising from use (shock against a pavement, localised wear) are often visible.

Radial run-out is an irregularity in the radius of the tyre, i.e. the tyre is not perfectly round. Imagine a slightly oval-shaped tyre, or one with bumps around its circumference, for example. As for imbalance, radial run-out is often due to small irregularities in the thickness of the tyre's components. On the road, radial run-out mainly causes **variations in radial forces** at the wheel centre, leading to vertical vibrations and sometimes noise in the passenger cabin.

Lateral run-out is an irregularity in the distance between the outside of the tyre sidewall and the wheel's plane of rotation. Imagine, for instance, a wobbly bicycle wheel after a crash. On the road, a wheel with major lateral run-out may be seen to wobble. Lateral run-out mainly causes **variations in lateral forces** at the wheel centre, leading to transversal vibrations in the passenger cabin.

Radial run-out

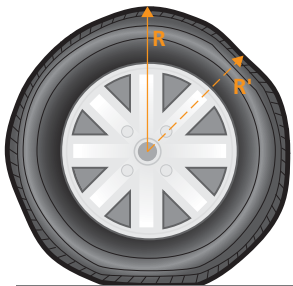

$R > R'$: the radius of the tyre, mounted on the wheel rim and inflated, is not perfectly regular.

$$\text{Radial run-out} = R_{\max} - R_{\min}$$

Lateral run-out

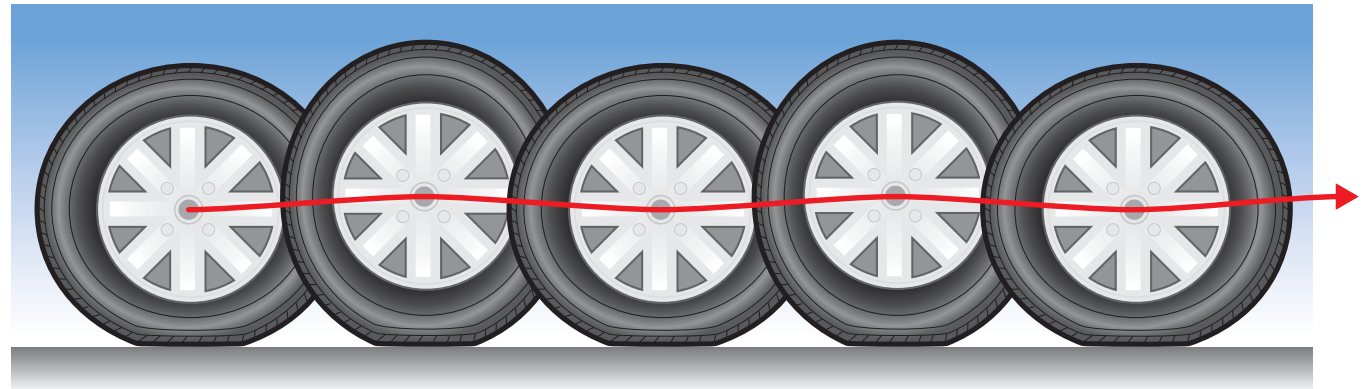

Radial run-out causes the wheel hub to follow a non-rectilinear trajectory. It oscillates vertically. When the tyre is under load, this results in variations in radial forces at the wheel centre.

■ STIFFNESS NON-UNIFORMITIES

Stiffness non-uniformities may be of two types:

- variation in radial stiffness,
- variation in lateral stiffness.

A tyre subject to **variation in radial stiffness** does not have exactly the same radial stiffness at every point along its circumference. Imagine a "tyre" composed only of springs of different stiffness. When the springs which are not very stiff reach the contact patch, the tyre compresses. When the stiff springs reach the contact patch, the tyre compresses less. The wheel centre follows a trajectory which alternately rises and falls. When loaded, this results in **variations in vertical forces** at the wheel centre.

There are many causes of variations in radial stiffness, such as variations in the radiality of the casing ply, variations in the thickness of components, and the presence of joints.

Like radial run-out, variations in radial stiffness generate **vertical vibrations** in the hub which can cause vibrations in the floor, seat and steering wheel, sometimes accompanied by noise.

A tyre subject to **variation in lateral stiffness** does not have exactly the same transversal stiffness at all points along its circumference. Similarly, this could be visualised as a "tyre" whose circumference is composed of transversal springs of various stiffness.

Variations in lateral stiffness are mainly due to variations in the density of the casing ply and the crown block plies.

Like lateral run-out, variations in lateral stiffness lead to **variations in lateral forces** at the wheel centre and hence to transversal vibrations in the passenger cabin.

NB Other force variations such as conicity or ply steer (also known as angle effect) are not addressed here since these are not causes of discomfort but characteristics which are deliberately used by designers to ensure adequate road handling.



Variation in radial stiffness

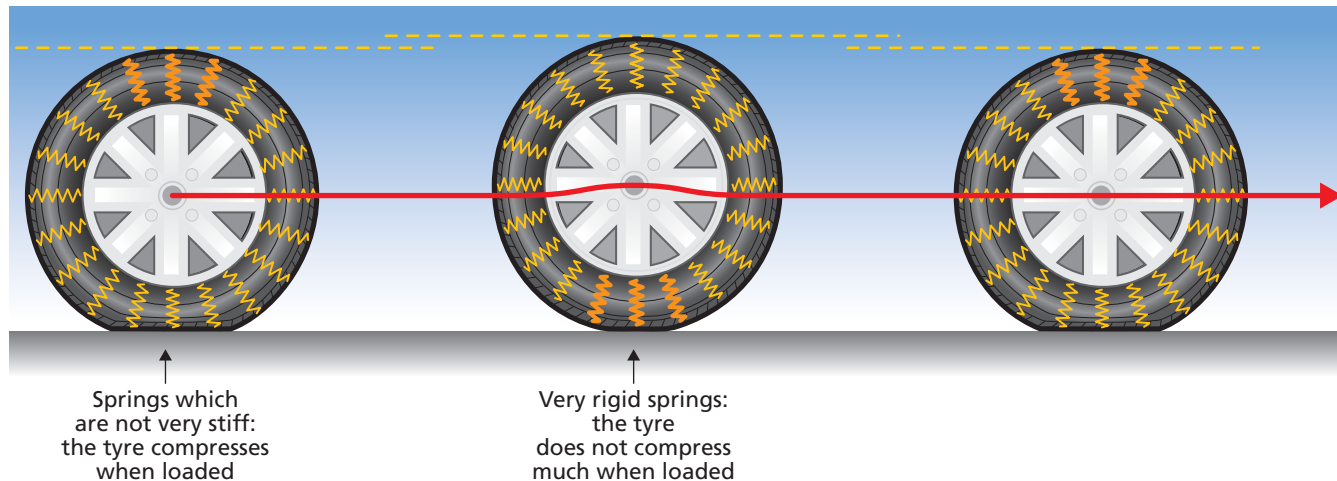

Variation in lateral stiffness

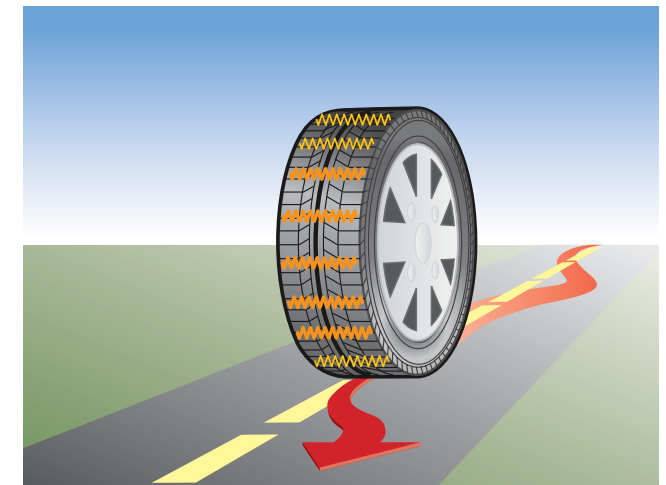

■ EXCITATION FREQUENCIES

The excitation frequencies caused by non-uniformities are multiples of the wheel revolution frequency. Thus, for a given tyre, they depend directly on the speed.

If the speed varies, the forces created by the non-uniformities successively excite the different natural frequencies of the components of the vehicle such as the mass of tyre/wheel assemblies (or "unsprung masses"), the floor or steering wheel, etc. These non-uniformity forces, which are exacerbated by the resonance of structures which have been excited, lead to vibrations which in turn cause jolts, prickling sensations and noise.

The non-uniformities of rotating assemblies mainly cause **mechanical vibrations** with a frequency between **5 and 40 Hz** in the floor, seats and steering wheel of a passenger car. These mechanical vibrations are often accompanied by **noise**, with frequencies which may reach **300 Hz**.

Revolution frequency of a passenger car tyre and a truck tyre as a function of speed

Speed in km/h	Speed in m/s	Frequency of wheel revolutions in Hz*	
		Car	Truck
18	5	2.8	1.7
36	10	5.6	3.3
72	20	11.1	6.7
108	30	16.7	10
144	40	22.2	13.3

* For a circumference of 1.8 m for a passenger car tyre and 3 m for a truck tyre.

A passenger car tyre rolling at 108 km/h will create a vibration with a frequency of 16.7 Hz if it has a single shape defect and of 33 Hz if it has two shape defects diametrically opposite each other. In this case, the 33 Hz frequency is the second harmonic (H2) of the fundamental frequency, 16.7 Hz (H1). Shape defects or stiffness defects may have harmonics greater than 16.

The complex vibrations felt within the passenger cabin are a combination of four excitations (one from each wheel). Two strong vibrations, one on the left and the other on the right, may give an acceptable result in the driver's seat.

Moreover, the extent of the vibrations continually varies because the vehicle wheels do not always rotate at exactly the same speed. Two vibrations from two tyre/wheel assemblies, which sum together at a given time, may cancel each other out a few seconds later so that passengers have the impression that they appear and disappear regularly. This is the **beating** phenomenon.

A little more information on...



... beating

When two vibrations (or two sounds) with very close frequencies are emitted simultaneously, they follow a cyclical pattern. The two signals successively go in and out of phase. If they have comparable amplitudes, they cancel each other out when they are in phase opposition, and sum together when they are in phase. The vibration therefore appears to double and then disappear periodically. This is **amplitude modulation**, commonly called **beating**.

The wheels of a vehicle may rotate at slightly different speeds. This may be due to differences in the slippage rate, when one wheel is decelerated more than another for instance. It may also occur when cornering (when the outside wheels rotate faster than the inside ones). These differences may cause dephasing of 180° over 500 m.

Beating is particularly noticeable when a vehicle is driven at high speed on a motorway with an even road surface.

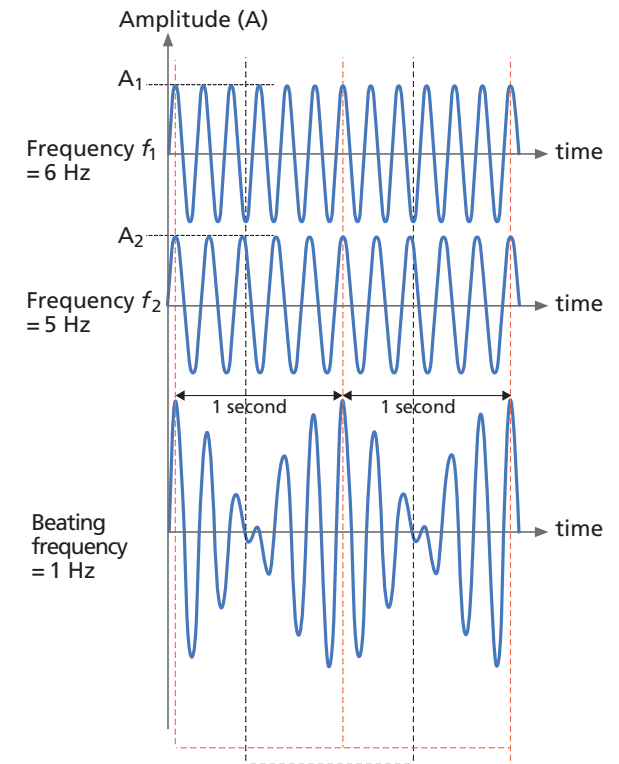

f_1 and f_2
are in phase opposition.
If $A_1 = A_2$: they cancel
each other out

$$A_{\text{resultant}} = 0$$

f_1 and f_2
are in phase:
they add to
each other

$$A_{\text{resultant}} = A_1 + A_2$$

The beating frequency is equal to the difference between the two frequencies emitted:

$$f_{\text{beat}} = f_2 - f_1$$



The flat spot

■ THE CAUSES OF NON-UNIFORMITIES

There are many causes of non-uniformity in a mounted assembly (wheel and tyre). They may be the result of slight variations in tyre or wheel manufacture, incorrect assembly or wheel balancing, or wear of the tyre during use.

		Mass NU*	Shape NU*	Stiffness NU*
Tyre manufacture	Variation in thickness of tyre elements	●	●	●
	Quality of joint on tyre tread	●	●	●
	Quality of joints on other components		●	●
	Variation in the radiality of the casing ply		●	●
Wheel manufacture	Radial run-out		●	
	Lateral run-out		●	
Assembly, balancing	Incorrect mounting of tyre on wheel	●	●	
	Incorrect centering of wheel on hub	●	●	
	Incorrect balancing	●		
Use	Prolonged parking leading to a flat spot on tyre		●	●
	Loss of balancing weights	●		
	Emergency braking leading to localised wear	●	●	
	Kerb impact		● (on a wheel)	

* NU: non-uniformity

Flat spots are localised non-uniformities which may occur if the tyre remains stationary a long time under load. The extent of this non-uniformity depends on factors such as the length of time the tyre is compressed, the temperature of the tyre and the load. The tyre itself affects the phenomenon due to the thermo-mechanical properties of the rubber and textile reinforcing.

A flat spot may occur after the vehicle has gone through a paint-drying tunnel or after lengthy transport by sea (vehicles are often tied down which compresses tyres and leads to distortion).

It may also occur if a car remains stationary for a long time, just after travelling a long distance at high speed (following a motorway run, for instance, which warms up the tyres).

While a **flat spot** caused by a paint tunnel (in which the temperature may reach 80° C) may be **permanent** and require changing the tyre, the parking flat spot is almost always **reversible**.



Non-uniformities related to tyre and wheel manufacture are subject to severe tolerance specifications and checks during manufacture, described in the annex on page 120.

Moreover, careful mounting of the tyre on the wheel may compensate for slight non-uniformities of the wheel and tyre, giving a uniform mounted assembly. This technique is called **match mounting**.

... match mounting

A little more information on...



Unlike tyres, the wheel is a rigid, homogeneous structure. Its stiffness non-uniformities are thus negligible. It may, however, be slightly irregular in shape, and may in particular have a slight radial run-out. Once a wheel has been fitted with a tyre, its radial run-out mainly leads to a variation in force. Indeed where the distorted radius of the wheel is greatest, the tyre is compressed more in the contact patch, and is thus stiffer. If carefully distributed, the areas of the wheel's radial run-out and the areas of the tyre's weak radial stiffness compensate each other. This then gives a tyre/wheel assembly with less variation in radial forces.

Principle of tyre and wheel addition

The non-uniformity of rotating assemblies is the vector sum of the wheel and tyre variations.

Random mounting

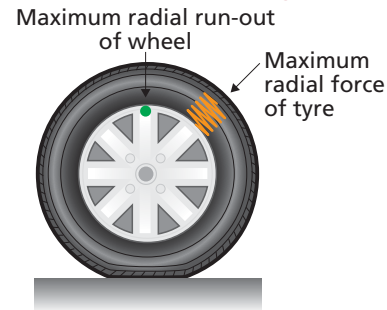

Vector representation

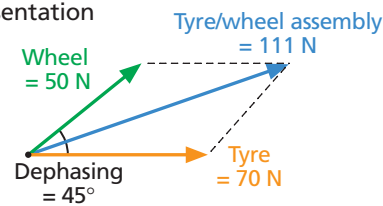

Sinusoidal representation

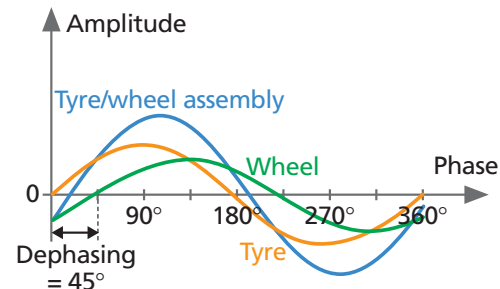

Match mounting

Match mounting consists of placing the maximum radial force of the tyre diametrically opposite the maximum radial run-out of the wheel in order to minimise the radial variation of the tyre/wheel assembly by compensation.

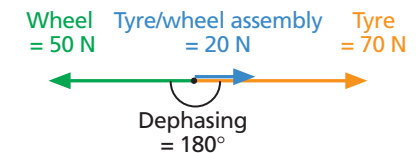
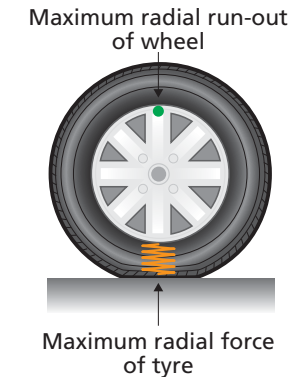

The same method is applied to compensate mass non-uniformities of the wheel and tyre.

IV.4

The mechanical comfort of vehicles without suspension

Some vehicles do not have any suspension. This is the case for most earthmoving loaders and farm vehicles, which nevertheless drive on particularly varied and rough surfaces. On these vehicles, the tyre is the only vehicle part capable of absorbing surface irregularities.

To improve comfort on irregular surfaces, tyre engineers have to be able to diminish the tyre's radial stiffness, in particular by lowering the inflation pressure. This is the case for farm vehicles, for which the inflation pressure can be reduced to 0.8 bars (ultra-low pressure under low loads), instead of the 2 bars of normal pressure. On small and medium-sized earthmoving loaders, increasing the volume of the tyre (i.e. enlarging the section width) makes it possible to reduce the inflation pressure by about 1 bar for a given load, depending on the use and position on the vehicle (i.e. a pressure which is often between 2 and 5 bars).

However, the tyres themselves may be a source of excitation. When driving over loose soil, large tyres need a very deep tread groove consisting mainly of bars or big blocks often called lugs. As they move into the contact patch, they can make the tyre and vehicle vibrate. The tyres and wheels of these vehicles may also have radial run-out.

EARTHMOVERS

For earthmoving, the notion of comfort is different to that for a car or a truck. In a mine or on a building site, comfort allows for increased productivity, expressed in tons per hour.

Limiting vehicle vibrations increases driver comfort. It thus improves work conditions and increases productivity while allowing sufficient speeds. It also prevents part of the load from being ejected from the bucket or skip under the effect of vibrations, and hence limits the number of trips needed and avoids having to clean the track regularly. The table below summarises the different vibratory disturbance mechanisms studied for earthmover tyres.



Vibratory disturbance on earthmovers

Excitation frequency	Source of excitation		Vehicle response	Improvement factor
	Ground	Mounted assembly		
< 5 Hz	Bumpy ground, like corrugated iron. Length of irregularities: 1 metre and more	Radial run-out of tyre and wheel	Bouncing, pitching (also called "gallop") and rolling. Possibility of exciting the vehicle's natural mode (in general about 1 to 2 Hz)	Improve the mounting and centering precision of the mounted assembly*
from 5 to 50 Hz	Rough surfaces, stones, etc. Length: a few cm to 20 or 30 cm	Succession of tread blocks in the contact patch	Vibration by excitation of the tyre's first modes (in general from 20 to 30 Hz)	Increase the angle of tread grooves in relation to the transversal axis (Y)
> 50 Hz	No vibratory disturbance, production of noise which does not disturb users			

* Earthmovers' wheels generally consist of five parts (a taper bead-seat band, a lock-ring and two flanges), which increases the risk of radial run-out.

Succession of tread blocks in the contact patch



Earthmover tyres have very big blocks in their tread pattern. These blocks do not vibrate, but their succession in the contact patch excites the tyre's natural modes in the same way as a smooth tyre rolling over an obstacle (cf. chapter IV.2).

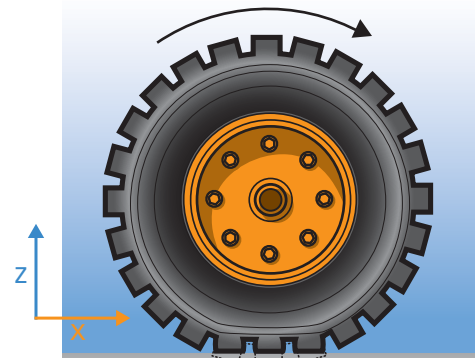

Leaving the contact patch
Decompression of block

Entering the contact patch
Compression of block

Forces at the wheel centre...

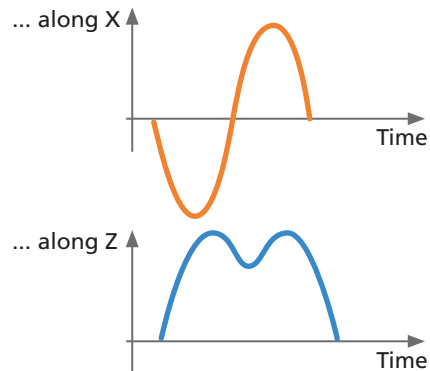

Increasing the angle of tread grooves



Vibratory comfort tests
for 4 different experimental tread patterns
compared with a smooth tyre on a loader (under load)

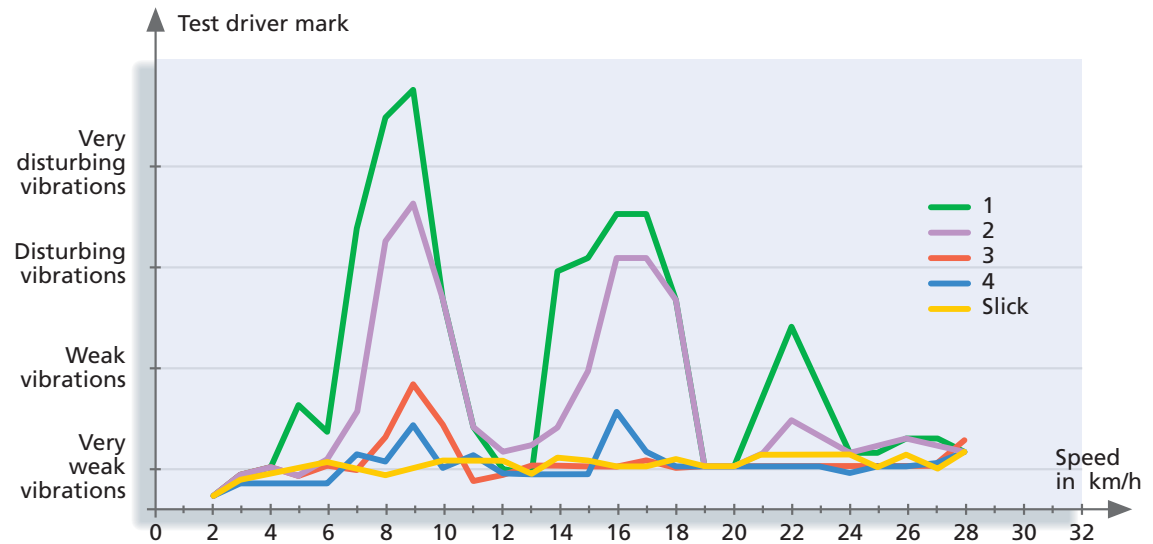

■ FARM AND FORESTRY VEHICLES

In agriculture, there are two meanings to comfort. On roads, the driver of a farm vehicle has the same expectations as a truck or car driver. In the fields, comfort means less fatigue over long working hours and higher productivity, as well as greater traction. Just as for earthmovers, limiting vehicle vibrations enables the driver to maintain sufficient speed for greater productivity. It also decreases the risk of damage when driving over ruts or furrows. The table opposite summarises the different mechanisms of vibratory disturbance studied for tyres in this category.

Excitation frequency	Source of excitation		Vehicle response	Improvement factor
	Ground	Mounted assembly		
< 10 Hz	Irregularities 1 metre long and more	Radial run-out of tyre and wheel	Bouncing, pitching and rolling. Possible excitation of the vehicle's natural mode	Lower inflation pressure.* Improve mounting and centering precision of the mounted assembly
from 10 to 30 Hz	Isolated obstacles such as ruts and ditches	Succession of tread bars in the contact patch	Vibration of the vehicle cab and exhaust stack	Lower inflation pressure.* Increase the angle of the bars in relation to the transversal axis and adjust their overlapping rate
> 30 Hz	No vibratory disturbance, production of noise which does not disturb users			

* According to tyre manufacturer's recommendation



Mounting precision

The wheels of farm vehicles often consist of a removable rim and disc. This makes it possible to change the track width of the vehicle (width between wheels of the same axle) according to the crop (row crops such as vegetables in Europe, cotton in the USA for example). Each mounting-dismounting operation may create radial run-out.

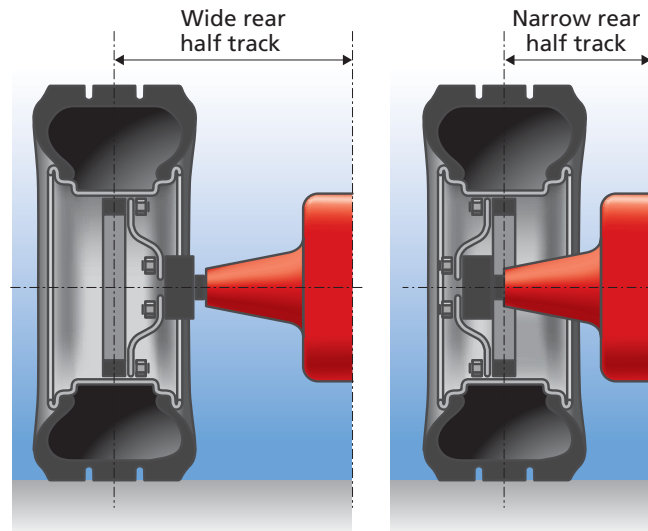

Nowadays, the angle of bars and their overlap rate have been optimised so that the succession of bars in the contact patch is no longer a significant source of vibrations.

IV Mechanisms leading to vibratory disturbance

Excitation

Non-uniformity



Impacts on isolated obstacles

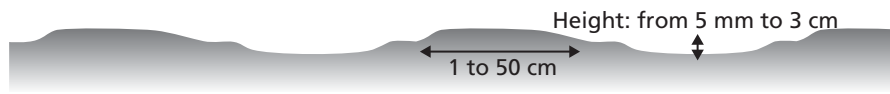

Jolting on bumpy roads

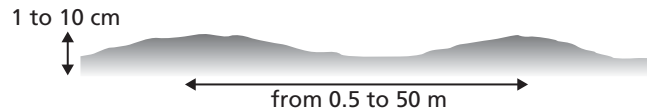

Frequency



Vibratory behaviour of tyre



Role of tyre

Phenomena felt in the cabin

Excitation factor

Longitudinal, vertical and transversal vibrations

Absorbs shocks, but can vibrate according to its natural modes

Impact, then longitudinal and vertical vibrations which last to a greater or lesser extent

Absorbs bumps; slight damping effect

Bumps and vibrations



NB:

The tyre deformations shown here are greatly exaggerated.



V *Mechanisms leading to acoustic disturbance*

The noise made by tyres rolling on a road surface is due to several phenomena, the major ones being impacts, friction and air compression.



The noise made by a rolling tyre is produced mainly by two sources of excitation:

- the roughness of the road surface,
- the tyre's tread pattern.

These two sources then generate vibrations in:

- the tyre structure,
- the air inside the tyre,
- the surrounding air trapped in the tread groove.

The vibrations can reach human beings in two ways:

- either by making the surrounding air vibrate directly (airborne propagation),
- or by making the vehicle components vibrate (structure-borne propagation). These then make the air vibrate, creating noise.

People may be affected by noise either inside or outside the vehicle.

The mechanisms which produce and propagate noise as a result of tyres rolling on a road surface are thus complex. Let us consider them more closely.



V.1

Interior noise - exterior noise

The noise made by moving vehicles can affect two categories of people:

- those inside the vehicle, i.e. the driver and passengers, in which case we refer to **interior noise**;
- those outside the vehicle, in other words, by-standers and local residents. In this case, the noise they perceive is known as **exterior noise***.

According to their situation, these two categories of people are not affected by traffic noise in the same way.

In the street, or alongside a road, only a few metres away, the noise produced by a passing vehicle is very loud. It may even be deafening if there is a continuous stream of traffic on several lanes, such as on an urban by-pass where the acoustic intensity level often reaches 80 dB(A).

Passengers inside a vehicle, even in an intense traffic flow, notice the noise of other vehicles less than their own. With their windows closed, which is increasingly the case given the widespread use of air conditioning systems, they mainly perceive the noise of their own vehicle.

Inside the car, the overall noise level is lower than on the side of the road. It is often considered acceptable (commonly 70 to 75 dB(A), depending on the vehicle, the tyres and the road surface). However, one or more specific noises may peak above the overall level and become annoying, or even uncomfortable.

Improving the acoustic comfort of passengers requires both reducing the overall noise level and analysing the frequency spectrum of the noise emitted by tyres so as to eliminate **peaks**.

On the other hand, for people nearby, improving acoustic comfort focuses on reducing the **overall power** of the source. This is why the standards and regulations on exterior noise produced by vehicles only mention noise levels.

Whether interior or exterior noise, the mechanisms of generation are the same. They will be described in this section, not forgetting that their respective significance will change according to driving conditions (type of road surface, vehicle, speed, acceleration, braking, cornering, etc.).

* The expression "exterior noise" may have two meanings: it may refer to exterior noise in general, such as we have described above, or the **"regulatory" exterior noise** defined by European directive 92/97 for specific driving conditions (vehicle at full throttle on a standard road surface).

V.2

Excitation by the road surface

V.2.1

Noise of impact against isolated obstacles

When tyres roll over isolated obstacles, as described in chapter IV.2, they produce not only mechanical vibrations but also acoustic vibrations.

These isolated obstacles may be manhole covers, road surface joints, speed bumps or potholes.

A vehicle driving over this type of obstacle produces a shock which makes the tyre vibrate according to its natural modes. The vibrations reach the car's passenger cabin through its suspension (structure-borne propagation). The vibrations are transmitted to the inner surfaces of the cabin, which then make the air vibrate, producing noise.

The excitation frequencies increase with the speed at which the obstacle is rolled over. They lie between 0 and 200 Hz.

Since people perceive mechanical vibrations more keenly at lower frequencies, the vibratory discomfort is greater when travelling slower. On the other hand, in the 0-200 Hz range, human sensitivity to noise increases with frequency. At high speed, the discomfort will thus be mainly acoustic.

■ POTENTIAL REDUCTION OF IMPACT NOISE PERCEIVED IN THE PASSENGER CABIN

The noise perceived inside the car depends on the tyres, the vehicle and the coupling of tyres with the vehicle. The pie chart below shows potential noise reductions which could be achieved by concentrating on the vehicle alone, the tyres alone and on the tyres and car together.

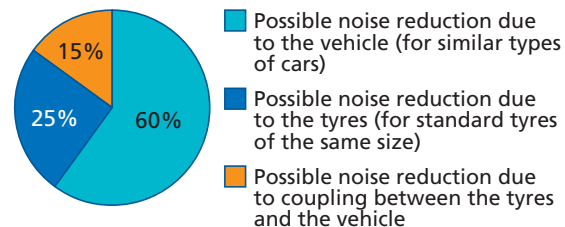

V.2.2

Road noise

Road surfaces often have aggregates of different sizes. If these aggregates are about one millimetre big, it is said that the road surface is **macrorough**.

On this type of surface, whenever a tread block touches the ground at the leading edge of the contact patch, it is as if being "hit" by the rough spots it encounters, a little like a drum by a drumstick. These impacts make the tyre vibrate, causing **road noise**.

... road surface roughness

A little more information on...



Road surfaces are mostly made of **aggregates** (small "stones" made by crushing hard rocks) **bound** together with bitumen. These aggregates may vary in size (from 6 to 14 mm), and in smoothness.

The bigger the aggregates on the road surface, the more **macrorough** the road surface, in other words rough on a millimetric scale. The smaller the aggregates or the more the road surface is worn or smoothed by frequently passing cars, the less macrorough the road surface. It is then said to be **macrosmooth**.

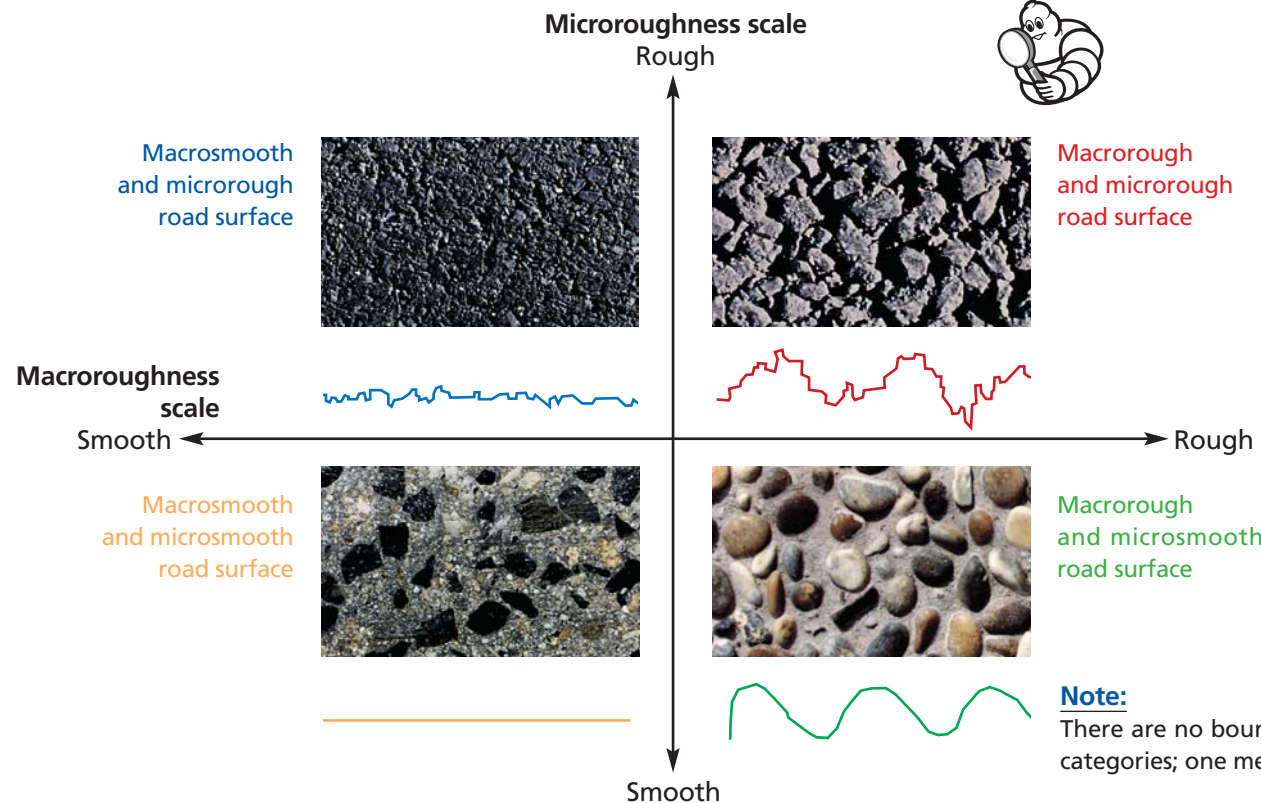

The surface of the aggregates themselves may have microrough spots (between 1 and 100 microns in size). It is then said that the road surface is **microrough**, in other words, rough on a micron scale or on a scale of a few hundredths of a millimetre.

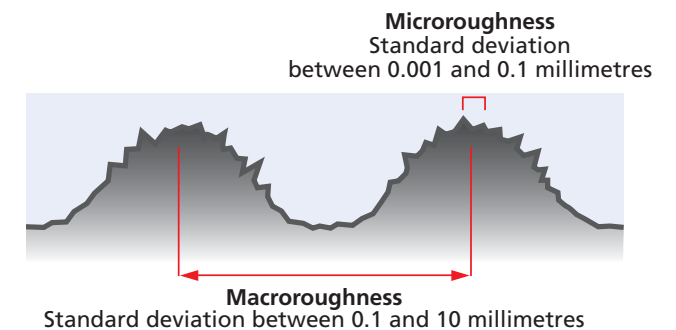

Even though a car driven on macrorough road surfaces can produce mechanical vibrations, passengers perceive mainly an auditory disturbance. Most of the acoustic energy lies **below 800 Hz**.

The roughness of the road surface excites the tyres and causes noise inside the passenger cabin by means of two different mechanisms:

- vibration of the tyre structure,
- vibration of the air inside the tyre.

■ VIBRATION OF THE TYRE STRUCTURE

The rolling of the tyre on a macrorough surface excites the tyre's structure at frequencies under 800 Hz. Chapter III showed that the 30-250 Hz range corresponds to the tyre's natural frequency range. In this frequency range, the tyre transmits its vibrations to the wheel centre, then to the passenger cabin, via the suspension components: the propagation is purely structure-borne. These vibrations are transmitted to the walls of the passenger cabin which then make the surrounding air vibrate, producing noise.

Above 250 Hz, the damping is greater. Due to its visco-elastic properties, tyre rubber quickly damps vibrations. The tyre vibrates mainly in front of and behind the contact patch. These vibrations are propagated to the passenger cabin through structures and air.



Example of a recording of road noise perceived inside the passenger cabin

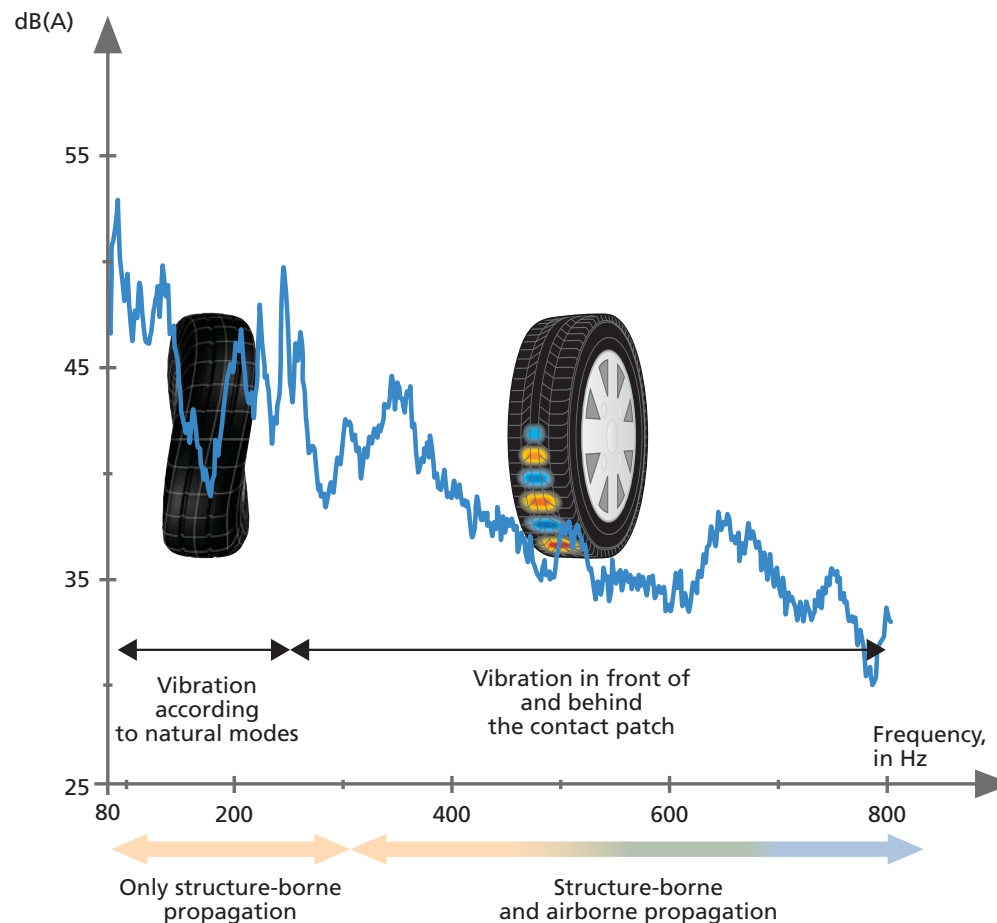

NB The lower study limit was set at 80 Hz because below this limit, the dominant noise is that of the engine.

Road noise is perceived inside the passenger cabin as a low, continuous and slightly muted rumble. It is easily identified when moving, for instance, from a macrorough motorway surface to a macrosmooth surface. The passenger cabin suddenly becomes much quieter as the rumbling noise stops.

To decrease road noise, one solution may be, of course, to modify the road surface:

- by decreasing its macroroughness, as long as its drainage capacities in wet weather are maintained;
- by using road surfaces which absorb noise efficiently, such as draining mixes or surfaces containing powdered rubber.

■ POTENTIAL REDUCTION OF ROAD NOISE PERCEIVED IN THE PASSENGER CABIN

The noise perceived inside the car depends on the tyres, the vehicle and the coupling of tyres with the vehicle. The pie chart below shows potential noise reductions which could be achieved by concentrating on the vehicle alone, the tyres alone and on the tyres and car together.

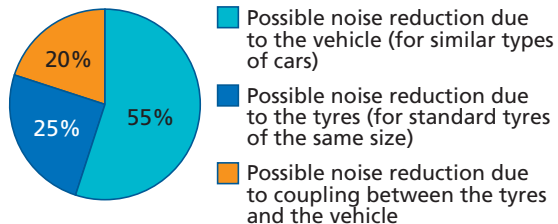

A little more information on...



... road noise in the passenger cabin

The intensity of the noise produced inside the passenger cabin is not uniform, so the driver and passengers may perceive it differently. This is because the cavity formed by the passenger cabin resonates according to its natural modes, whose mode shapes have anti-nodes and nodes. The acoustic pressure felt by the passenger is stronger near a vibration anti-node (maximum vibrations) and much less near a node (vibrations close to zero).

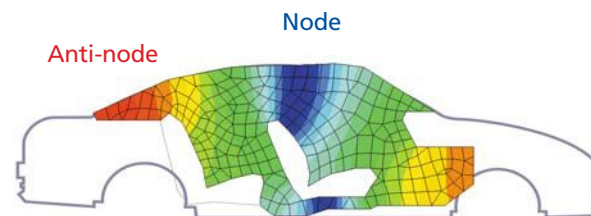

These cavity modes are compounded by the resonance modes of certain vehicle parts (e.g. windscreen resonance, around 100 Hz), and the effect of the absorption or reflection properties of the furnishings, which sometimes create complex distributions of acoustic pressure.

■ VIBRATION OF AIR INSIDE THE TYRE

The rolling of the tyre on a macroroughness surface not only excites the tyre structure, but also the air inside the tyre. The column of air imprisoned in the tyre has its own natural modes. Its first natural mode, called **cavity mode**, lies between 200 and 250 Hz for a typical passenger car tyre, depending on the size of the envelope. When the column of air starts resonating, it creates acoustic pressure on the wheel which can cause it to vibrate. The wheel then transmits its vibrations to the wheel centre, then to the passenger cabin through structure-borne propagation.

The **cavity noise** perceived inside the car sounds like a panpipe.

The disturbance caused by the first cavity mode can be reduced by changing the tyre/wheel coupling and the tyre/vehicle coupling so that the air column's natural frequencies do not coincide with those of the wheel or passenger cabin.

The first cavity mode

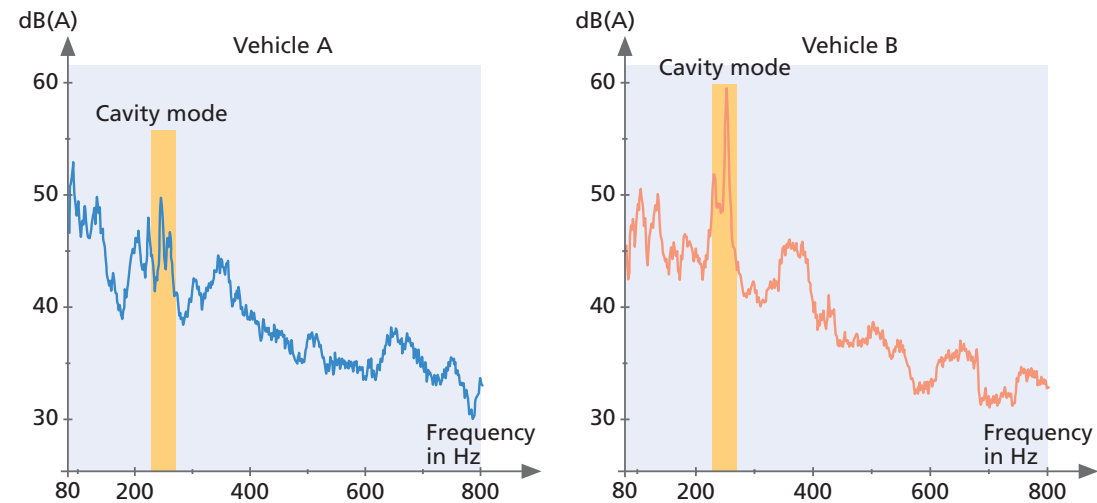

Some vehicles filter the cavity mode better than others.

Estimation of the frequency of the first cavity mode

- For an unloaded tyre

$$f = \frac{c}{2\pi R}$$

where c is the speed of sound propagation in the fluid

$$\text{and } R = \frac{R_1 + R_2}{2}$$

If $R = 0.25$ metres

and $c = 340$ m/s (speed of sound in air),

then $f = 216$ Hz

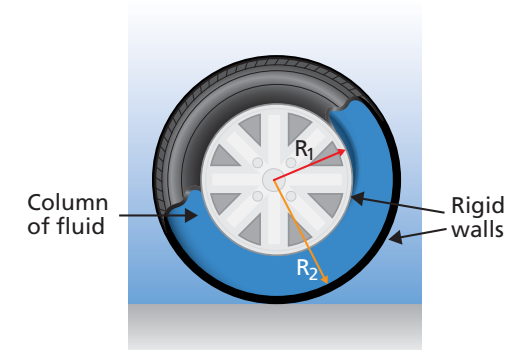

- Rolling a tyre under load changes the geometric characteristics of the air column and splits the resonance frequency into two peaks a few hertz apart.



V.3

Excitation by tread pattern

V.3.1

Impact of tread blocks on the road surface

The force exerted on the tyre belt in the contact patch differs according to whether the tread pattern has a **rubber block** or a **groove** at that place. The inner side of the belt is constantly subjected to the inflation pressure, whereas the outer side is only subjected to a road surface/tyre reaction force if the tread at that point is a rubber block and not a groove.

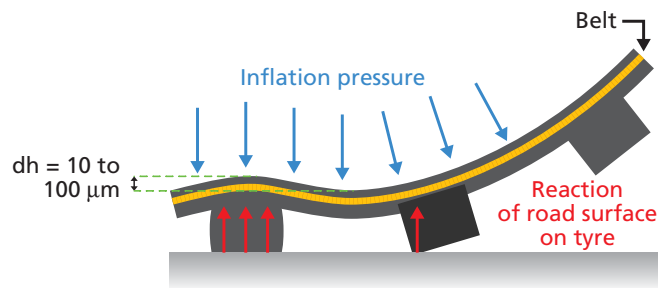

At the leading edge of the contact patch of a rolling tyre, those parts of the belt located above a rubber block are subjected to an upward acceleration, whereas those located above a tread groove are not.

At the trailing edge of the contact patch, the situation is similar. Only those parts of the belt located above a rubber block are accelerated, though this time downwards.

A little more information on...



... vibrations affecting the tyre belt at the leading edge of the contact patch

Hypotheses:

Vehicle speed: 80 km/h, i.e. 22.2 m/s

Length of contact patch: 0.1 m

Length of rubber block: 0.02 m

Time taken by the rubber block to settle on the road surface:

$$dt_{\text{touch}} = \frac{0.02}{22.2} = 0.9 \text{ ms}$$

Elevation of the belt above the rubber block:

dh = 0.1 mm

Calculations:

Mean **speed** of belt elevation:

$$\dot{z} = \frac{dh}{dt_{\text{touch}}} = 0.11 \text{ m/s}$$

Acceleration borne by the belt:

$$\ddot{z} = \frac{2\dot{z}}{1/2 dt_{\text{touch}}} = 494 \text{ m/s}^2$$

Hypotheses:

Accelerated mass: m = 5 g

Surface area of belt above rubber block: S = 5 cm²

Calculations:

Force applied to the belt:

$$F = m \times \ddot{z} = 5 \times 10^{-3} \times 494 = 2.47 \text{ N}$$

Extra pressure acting on the belt:

$$P = \frac{F}{S} = \frac{2.47}{5 \times 10^{-4}} = 5 \times 10^3 \text{ Pa} \quad \text{i.e. } 0.05 \text{ bar}$$

Hypotheses:

Circumference of tyre: 1.8 m

Wheel revolution time:

$$\frac{1.8}{22.2} = 0.08 \text{ s}$$

Number of rubber blocks on a tyre circumference: 78

Calculations:

Frequency of block impact on a road surface at the leading edge of the contact patch (= frequency of end of contact between block and road surface at trailing edge of contact patch):

$$f = \frac{78}{0.08} = 961 \text{ Hz}$$

These accelerations make the tyre tread vibrate in front of and behind the contact patch, at frequencies which depend directly on the rate at which the rubber blocks and tread grooves follow each other in the contact patch. These frequencies are often close to 1 000 Hz for a passenger car tyre and 750 Hz for a truck tyre. When the tread vibrates, it makes the surrounding air vibrate, which produces noise both inside and outside the passenger cabin or truck cabin.

To minimise the auditory disturbance caused by the impact of the tread blocks on the road surface, tyre engineers design the tread to:

- eliminate peaks, which are the main cause of passenger discomfort;
- reduce the overall acoustic intensity level.

The main two types of annoyances which can be caused by the rubber blocks of a non-optimised passenger car tyre hitting the road surface are **tread whine** and **beating**.

■ TREAD WHINE

Let us observe a tyre. Its tread consists of a succession of identical elements which give an overall pattern. This could be visualised by looking at a transversal strip of the tyre tread to see what we refer to as a **tread element**. It could also be visualised as "cut out" by following the contours of the drawing and in this case we would refer to a **matrix**.

Let us now look at the tyre more closely. It may be seen that the tread elements, even though they all have the same design, are not all of the same length. The tyre has several different element sizes in order to avoid tread whine.

To study tread whine, let us consider a car rolling on a smooth road surface, thus eliminating noises due to road surface roughness.

The rate of impact of the rubber block on the road surface at the leading edge of the contact patch is given by the rate at which the tread elements follow each other. If the elements are all of the same size, then they will have a perfectly regular rhythm which can easily be calculated.

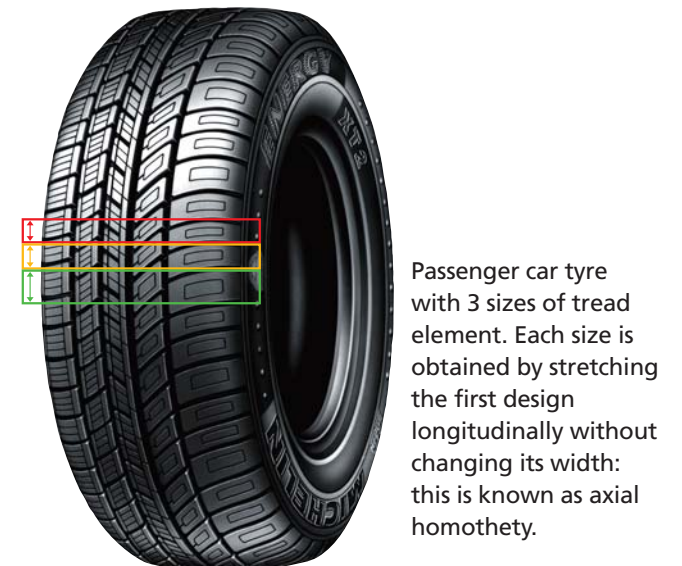

Review:

Around 1 000 Hz, there is substantial damping. Due to its visco-elastic properties, tyre rubber quickly damps vibrations which cannot then propagate all around the tyre. The tyre mainly vibrates in front of and behind the contact patch.

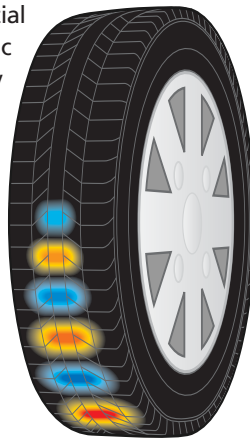

Hypotheses:

Tyre circumference: 1.80 metres

Speed: 28 m/s i.e. 100 km/h

Number of wheel revolutions per second: $\frac{28}{1.80} = 15.5$

Calculation:

for a tread having only 2.4 cm elements

Number of elements on tyre circumference:

$$\frac{180}{2.4} = 75$$

Frequency of impact of elements: $f = 75 \times 15.5 = 1\,162\text{ Hz}$

Calculation:

for a tread having only 3 cm elements

Number of elements on tyre circumference:

$$\frac{180}{3} = 60$$

Frequency of impact of elements: $f = 60 \times 15.5 = 930\text{ Hz}$

At 100 km/h, a tread pattern of this kind, known as a **single pitch**, will emit a frequency peak close to 1 000 Hz for a passenger car tyre thus making a sound known as **tread whine**. Tread whine emerges above the overall level of vehicle noise and can be most disturbing.

To avoid this problem, the tread pattern for all passenger car tyres consists of several element sizes. The tyre is said to have **variable pitch**.



Using several element sizes makes it possible to **randomise** the sound signal emitted by the tyre pattern, thus decreasing the peaks and tending towards a white noise.

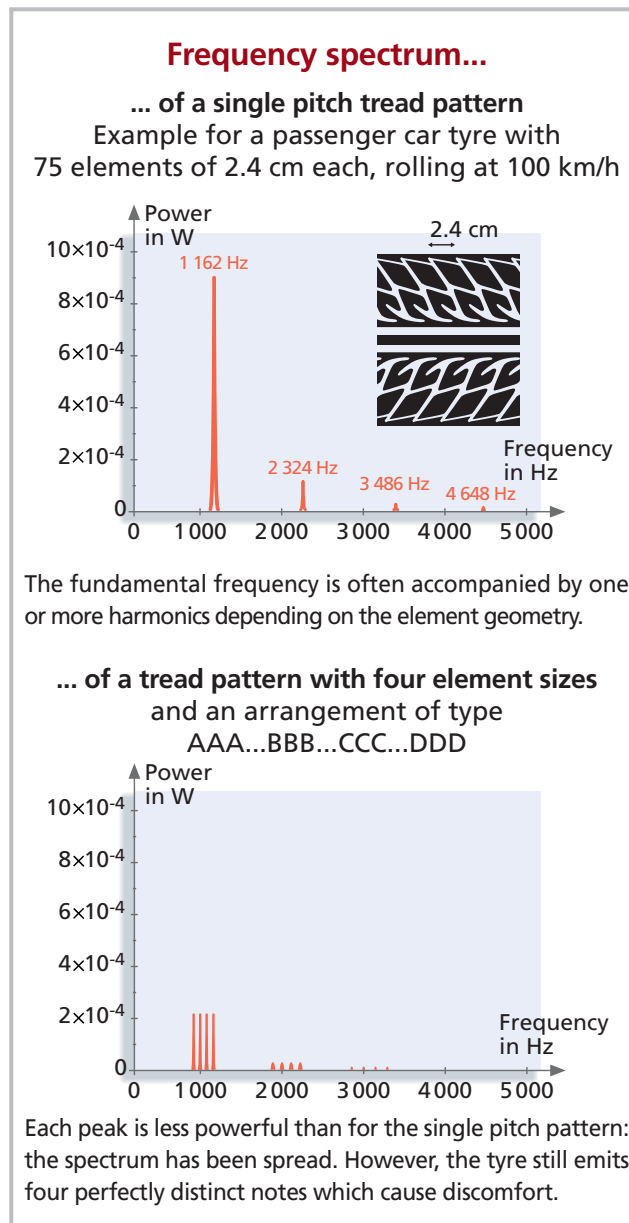

Let us consider four element sizes, called A, B, C and D. If A = 24 mm, B = 26 mm, C = 28 mm and D = 30 mm, the fundamental frequencies emitted at 100 km/h by the corresponding single pitch tyres would be 1 162 Hz, 1 073 Hz, 996 Hz and 930 Hz respectively. If a tyre were designed with the following sequence of elements:

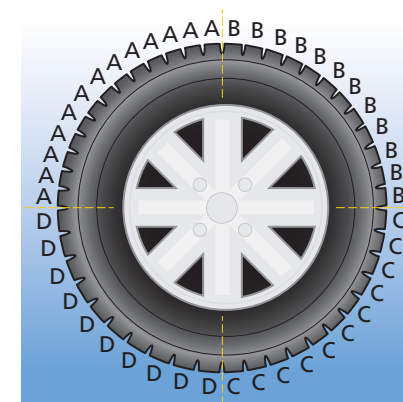

we would hear the four pure sounds corresponding to the frequencies given above whenever the wheel makes a complete revolution.

The sequence of elements is called an **arrangement**.



With the above arrangement, the intensity of each sound is divided by approximately four, but the rapid succession of the four notes is still disturbing.

Tread pattern



adjustment ("bouclage" in French)

To scramble these four peaks, engineers have to design a more random type of sequence such as

AABCAAADDDCDABBCADDCCBBBAAD

However, experience has shown that a completely random sequence would not be satisfactory. Moreover, there are a considerable number of possible arrangements, in direct proportion to the number of element sizes used. The number of element sizes also directly affects the manufacturing cost for curing moulds. Three to four element sizes allow for a good compromise between performance and price.

For only 3 element sizes and for 75 elements, there are 10^{31} possible combinations. At a rate of one per second, engineers would need billions of years to deal with all of them!

Tyre engineers therefore draw on their experience to model a limited number of satisfactory combinations. These combinations are then optimised with dedicated software in order to smooth out any remaining peaks.

Let us take a tread pattern consisting of four element sizes:

A = 2.4 cm, B = 2.6 cm, C = 2.8 cm and D = 3 cm.

The tread pattern should of course only have complete elements and the sum of the element lengths should be equal to the tyre's circumference, give or take 0.5 cm (when the mould is manufactured, it is possible to adjust each element by ± 5 hundredths of a millimetre).

If the tyre circumference is 180 cm, the element arrangement should satisfy the following condition:

$$a \times 2.4 + b \times 2.6 + c \times 2.8 + d \times 3 = 180 \pm 0.5 \text{ cm}$$

a, b, c and d should be whole numbers.

Quantified example:

$$16 \times 2.4 + 17 \times 2.6 + 17 \times 2.8 + 16 \times 3 = 178.2 \text{ cm}$$

↑
unsatisfactory

$$13 \times 2.4 + 17 \times 2.6 + 17 \times 2.8 + 19 \times 3 = 180 \text{ cm}$$

↓
satisfactory

Number of possible arrangements

For a tyre with N elements of three different sizes A, B and C the number of possible combinations is equal to:

$$\frac{(N-1)!}{n_A! \times n_B! \times n_C!}$$

where n_A , n_B et n_C are the number of elements for each size,
and $n!$ is the factorial function equal to:
 $1 \times 2 \times 3 \times 4 \times \dots \times n$.

Quantified example:

For N = 75, $n_A = 25$, $n_B = 27$ et $n_C = 23$
the number of possible combinations is:

$$\frac{74!}{25! \times 27! \times 23!} = \frac{3.31 \times 10^{107}}{1.55 \times 10^{25} \times 1.10 \times 10^{28} \times 2.59 \times 10^{22}} = 7.5 \times 10^{31}$$



The optimisation software determines which group of elements gives the highest spectrum peak. It then corrects the arrangement of the tread pattern at this place. A further computation is needed to obtain a new frequency spectrum whose main peak has been smoothed. The software then identifies the next biggest peak in this new spectrum, and so on until it is no longer able to improve the tread pattern.

Spectrum spread obtained by changing a tread pattern arrangement
Measurement at 110 km/h

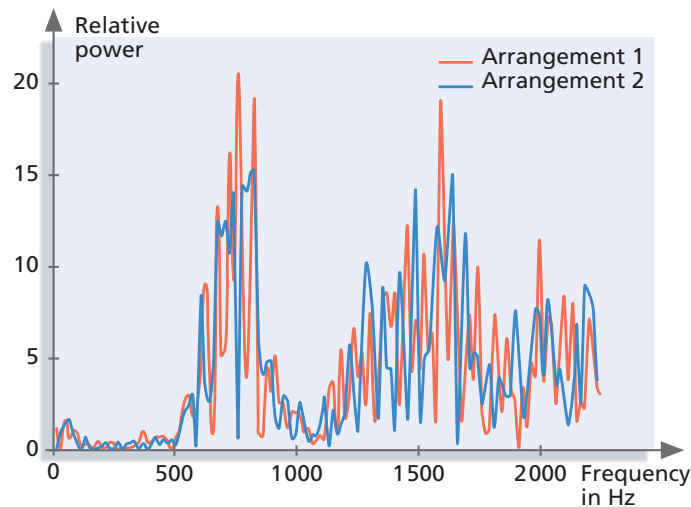

The diagram shows a comparison of two arrangements having the same number of elements of each size. The spectrum of arrangement 2 (in blue) is spread out more than the spectrum for arrangement 1 (in red), i.e. the peaks are less pronounced.

■ AMPLITUDE MODULATION OR BEATING

The human ear is usually capable of distinguishing between two sounds emitted at the same time. However, if the two sounds have similar frequencies, it does not perceive two distinct sounds but a single one (in other words, a single frequency), whose amplitude varies over time and which appears to "vary" in intensity around the same note. The ear hears a "wao-wao-wao..." type sound. What exactly is happening?

When two similar frequency signals are emitted simultaneously, they are alternately in phase (their amplitudes combine to form a greater amplitude), and out of phase (their amplitudes partly cancel each other out): this is the **amplitude modulation** phenomenon commonly known as **beating**.

Principle of amplitude modulation

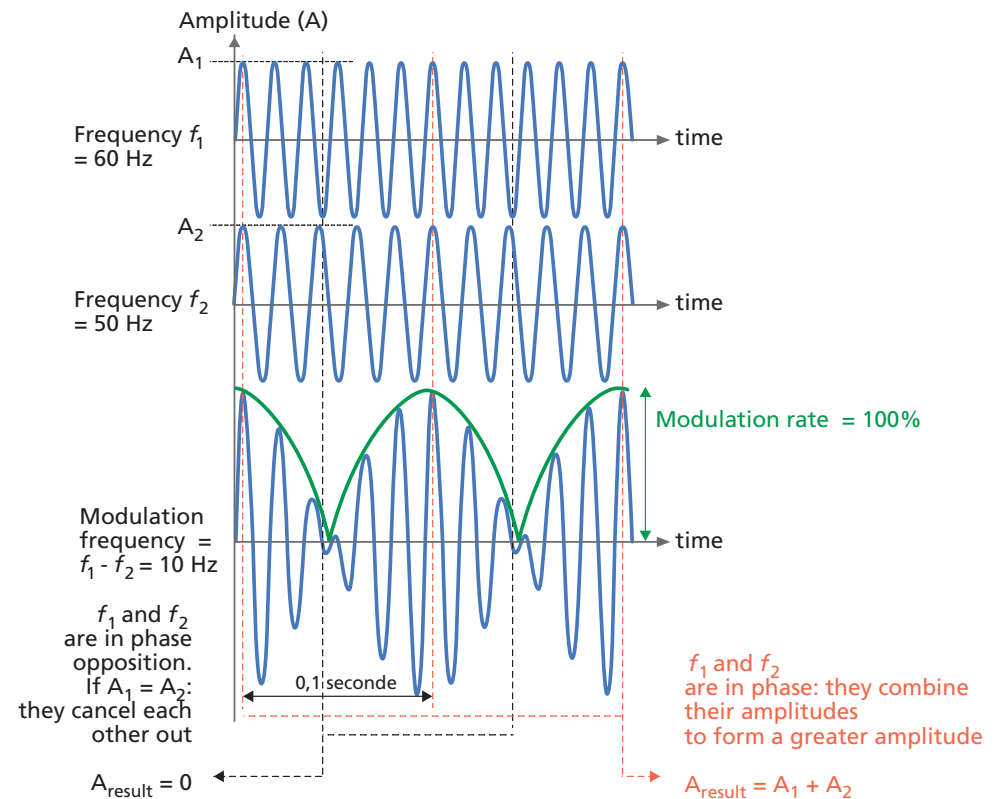

Several factors affect the way in which the human ear perceives an amplitude modulation. The perception will be clearer:

- if both modulating sounds have high amplitudes;
- at a high modulation rate;
- if the modulation frequency is below 15 Hz*, with a sensitivity peak at 4 Hz.

A tread arrangement might thus lead to beating if its element sizes are very similar, thus causing intense peaks with similar frequencies. To avoid this, engineers have to find an arrangement in which the element sizes are not "too" similar.

* The 15 Hz limit holds true for pure sounds. It may be higher for complex sounds such as those perceived inside a vehicle.

Sensitivity of the ear to modulation as a function of modulation frequency

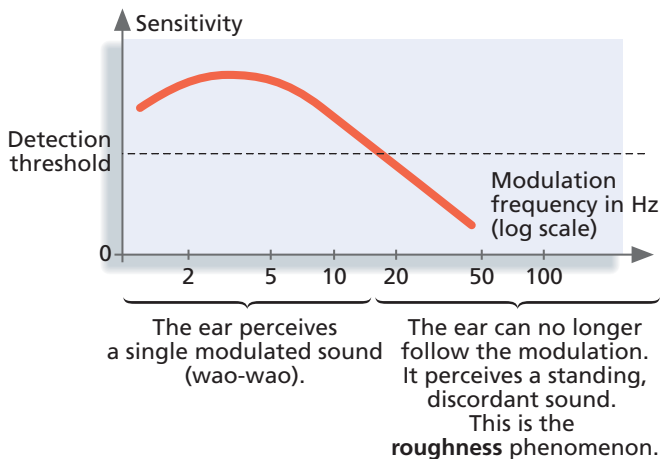

■ TREAD WHINE AND BEATING: THE ART OF ARRANGING TREAD PATTERNS

The maximum size of an element is limited because grip on wet surfaces requires a good void/rubber ratio. Its minimum size is also limited for reasons of road handling and wear (a tread with too great a void/rubber ratio would not be rigid enough).

Tyre engineers must design tread patterns with element sizes which are sufficiently different to avoid the risk of beating. Within a given range (defined by the maximum and minimum sizes possible for a tread block), keeping a sufficient difference between two consecutive elements entails **reducing** the number of elements. However, the number of element sizes has to be **increased** to limit the risks of tread whine.

Designing a tread pattern arrangement is by no means straightforward. It entails striking a balance between increasing the number of element sizes to avoid tread whine yet limiting it to avoid beating.

The graph on the left shows some approximate values. The detection threshold actually depends on many factors such as the frequency band and signal amplitude.

Risk of beating and tread whine

Arrangement with 5 element sizes

Size of elements in mm	24	26	27	28	30	
Fundamental frequency generated at 50 km/h in Hz	583	538	518	500	466	
Difference in Hz	45		20		18	
			34			

This kind of tread pattern is not likely to "whine" but there is a risk of beating because the frequencies are so close together.

Arrangement with 2 element sizes

Size of elements in mm	24	30
Fundamental frequency generated at 50 km/h in Hz	583	466
Difference in Hz	117	

With this kind of arrangement the risk of beating is low but the tyre emits tread whine.



■ ACOUSTIC LEVEL

The overall noise level produced by the impact of tread blocks at the leading edge of the contact patch and their release at the trailing edge directly depends on the magnitude of the belt vibrations, which can be reduced by changing two parameters on the tread pattern:

- increasing the thickness of the tread base (in between blocks);
- decreasing the width of the groove.

Belt vibrations caused by the impact of tread blocks on the road surface at the leading edge of the contact patch and their liberation at the trailing edge decrease...

... as
**the thickness of the tread base
 (in between blocks)**
 increases

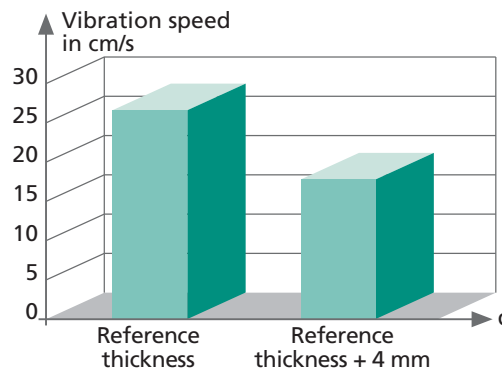
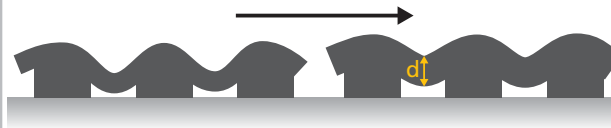

... as
the width of the transversal groove
 decreases

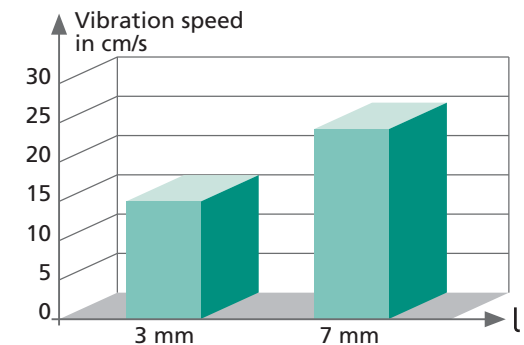
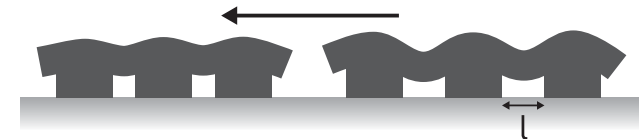

NB the above illustrations are greatly exaggerated, the actual distortions not being visible to the naked eye (10 to 100 microns).



The noise level can also be reduced by dephasing the excitation sources. The tyre belt thus vibrates less at any given time.

Since the source of vibration consists of "block/groove" boundaries at the leading (then at the trailing) edge of the contact patch, it is the boundaries which have to be staggered. Engineers have to design a tread pattern which is not regular like a chocolate bar:

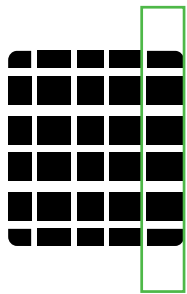

Straight-line leading edge: all the blocks over the width of the tyre touch the road surface at the same time.

Direction of travel

but rather a tread which is irregular along a transversal axis.

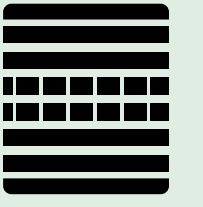
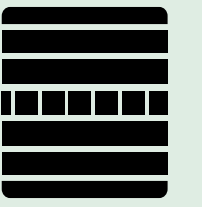
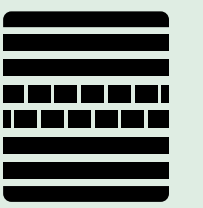
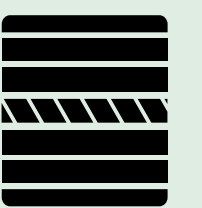
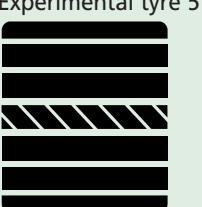

There are two ways of doing this: staggering the grooves or placing them at different angles.

Staggering tyre grooves			Varying groove angle		
	Phase	Acoustic power level (at 110 km/h)		Angle	Acoustic power level (at 110 km/h)
Experimental tyre 1 	0	98.9 dB	Experimental tyre 3 	0 deg.	92.2 dB
Experimental tyre 2 	half pitch	89.9 dB	Experimental tyre 4 	30 deg.	89.7 dB
			Experimental tyre 5 	45 deg.	87.4 dB

Note:
The acoustic power is measured in an anechoic chamber using sensors fitted around the tyre (intensity measurement). This measurement is used to characterise the different tread pattern solutions. The differences recorded for different tread patterns are much more significant than those that would be recorded inside the passenger cabin or alongside a road.

V.3.2

Noise of rubber friction on the road surface

On the road, there is permanent friction and micro-slippage in the contact patch between the rubber and the road surface, thus allowing the tyre to grip.

All slippage produces noise. Rubbing two pieces of cloth together produces a rustling sound. The slipping of chalk on a blackboard can produce a squealing sound. The type of noise produced depends on the texture of the two materials and the speed of slippage.

■ SIZZLING

When a vehicle is driven at stable speed, tread blocks slipping on a road surface produce a **sizzling sound**. This sound, which an uninitiated driver will have difficulty hearing, is similar to the better known noise produced by driving a car on a damp road. It is a high frequency noise with frequencies between 800 and 4 000 Hz, generally with a low amplitude.

Take the example of a crystal glass: by rubbing a finger around the rim, we can make the glass "sing". The finger does not slide around the rim uniformly. Sometimes it "sticks" to the rim because of the intermolecular bonding between skin and crystal. When the force exerted by the finger overcomes the intermolecular forces, the finger suddenly "breaks free" and slides further along. This procedure is

repeated all the way around the glass. It is known as slip-stick friction.

Whenever the finger pushes without moving forward, it accumulates energy. Whenever it breaks free, it liberates this energy. This liberation of energy is enough to make the glass vibrate at its natural frequency and produce a pure note... as pure as crystal.

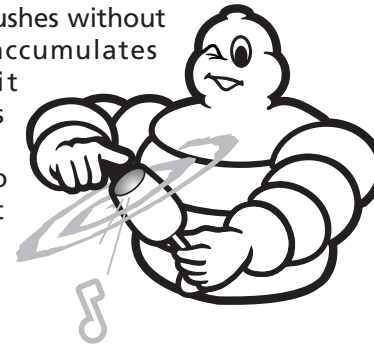

Similarly, in the contact patch, rubber blocks **slip and stick** on the road surface thus generating vibrations. When leaving the contact patch, the rubber block is suddenly released and is said to **relax**. It then slips more on the road surface.

■ SQUEALING

Under certain conditions, the tyre's tread blocks rub more on a road surface. This is the case during cornering, braking and accelerating. The rubber blocks at the rear of the contact patch slip on the road surface faster than during stable driving. The energy freed by this slippage is thus greater, and can produce a louder noise known as **squealing**.

Squealing is typically produced on painted floor surfaces such as those in underground car parks.

Slippage of a tread block on the road surface

Example of slipping during acceleration

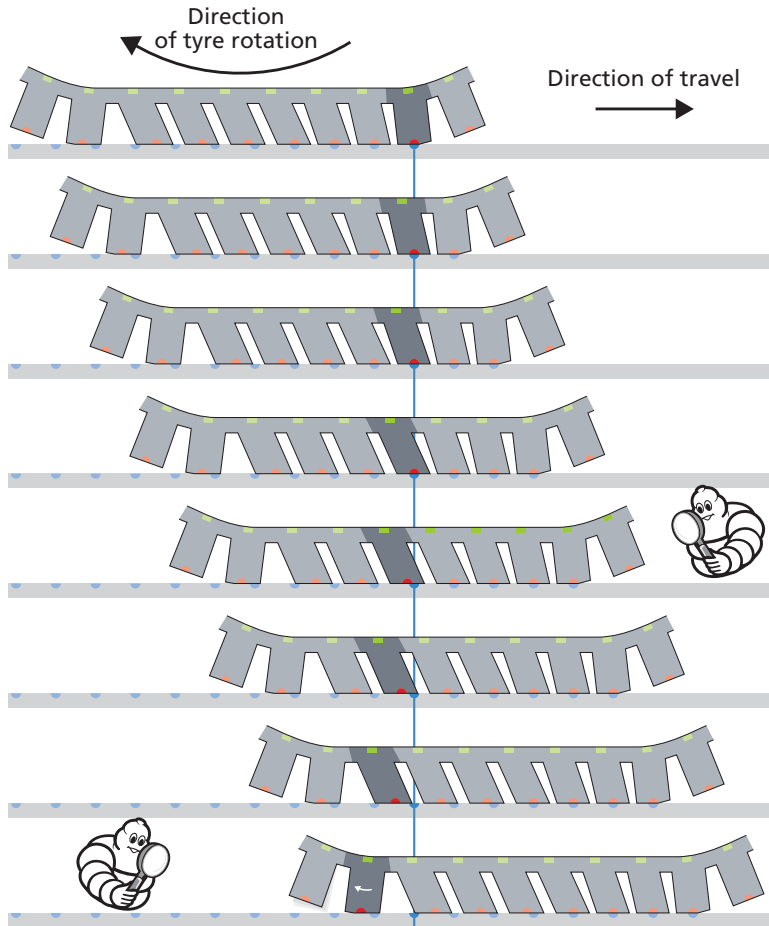

- The block touches the road surface

- The block inclines more and more to stay in contact with the point on the road surface where it first touched. As it inclines, it stores energy.

- The block starts to **slip and stick**: it liberates energy and starts vibrating.

- As it **leaves the contact patch**, the block loses contact with the road surface and straightens up suddenly, freeing all the energy it has stored up to then.

Similar friction phenomena occur at a constant speed as well as during braking or cornering. If the need for grip is only moderate (straight line, mild braking, mild acceleration, large bend), the friction of the tread blocks on the road surface produces a **sizzling sound**. If the grip stress is stronger (emergency braking, strong acceleration, tight cornering at high speed), then the friction can produce **squealing**.

Zoom on slip-stick motion

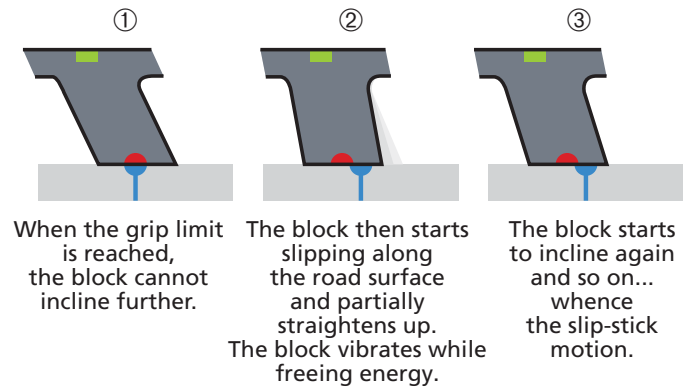

Zoom on block relaxation when leaving the contact patch

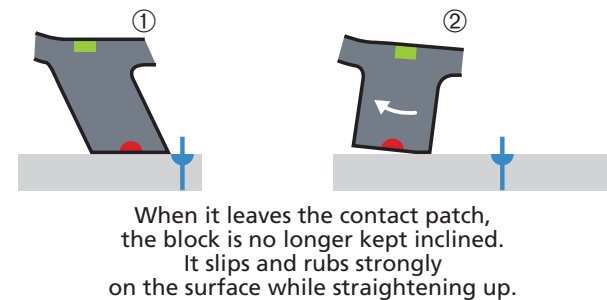

- Point on the belt
- Point on the tyre tread in contact with the ground
- ⊥ Point of initial impact with the road surface

V.3.3

Air pumping

When a tyre is rolling along a surface, the tread blocks touching the ground at the leading edge of the contact patch imprison air in the tread grooves (①). The tyre tread is then compressed under the load, thus reducing the groove volumes. The imprisoned air is also compressed (②), before being suddenly released when it leaves the contact patch (③), a little like opening a bottle of sparkling water.

The noise produced by this **compression/decompression phenomenon** is called **sizzling** (like the noise produced by the friction phenomena addressed in section V.3.2).

 The more blind grooves* in the tread and the smoother and less cracked the road surface, the greater the air pumping since the air will not be able to escape so easily before leaving the contact patch.

V.3.4

Amplifying phenomena

THE ORGAN PIPE

The sounds generated by the contact between the tyre and the road surface can be amplified if the air in the tread voids starts resonating, particularly in the circular grooves. The air then vibrates in this network like air in a wind instrument such as an organ. The frequencies amplified in this way lie mostly around 1 000 Hz.

* A lateral groove that does not open to a circumferential groove.

Sizzling by air pumping

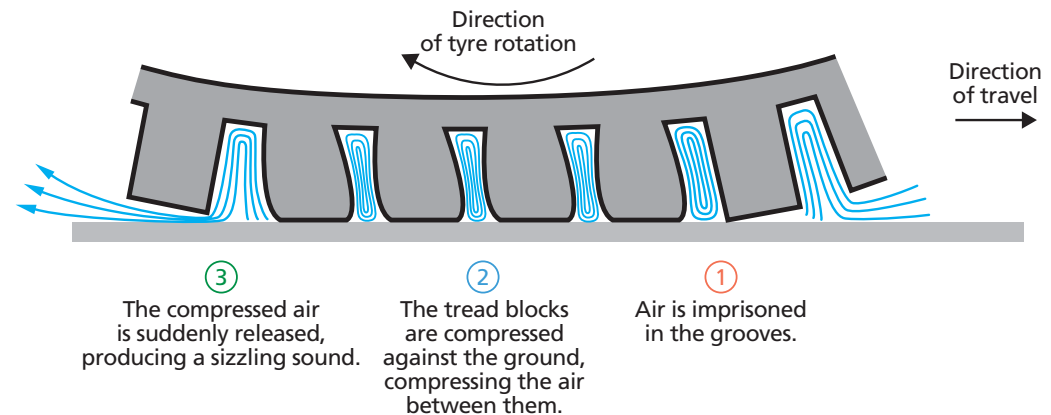

Calculating the frequency of an organ pipe

It is known that the first natural mode of a pipe open at both ends is such that:

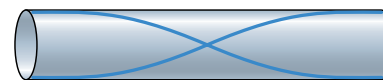

$$\lambda = 2L \quad \text{and} \quad f = \frac{c}{\lambda} = \frac{c}{2L}$$

Notation:

L : length of pipe (in the case of the tyre shown opposite,

L = length of contact patch + length of the two horn-shaped areas)

λ : wavelength

c : speed of propagation of sound in air (340 m/s)

Quantified example:

Passenger car: if L = 180 mm, then $f = 944$ Hz

Truck: if L = 260 mm, then $f = 653$ Hz

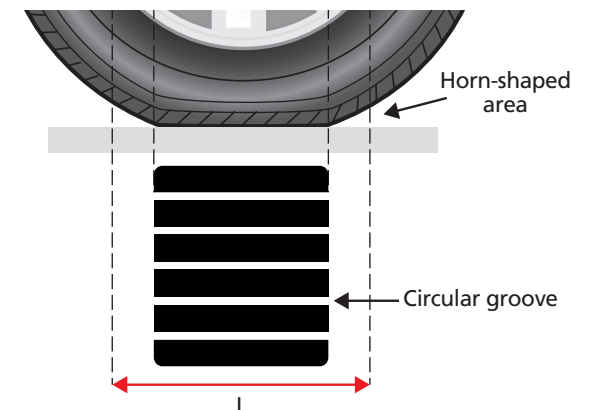

■ THE HORN EFFECT

In front of and behind the contact patch, the tyre and the road surface form two horn-shaped areas. These two areas amplify all the noises generated by the different sound sources in these areas.



Horn geometry is such that horns have an amplifying effect which increases up to 1 000 Hz and then stabilises around 2 000 Hz.

Chapter III showed that above 250 Hz, the tyre mainly vibrates in front of and behind the contact patch, which is precisely where the horn effect is located.

This partly explains why, in spite of the very low energy emitted by a tyre's surface vibrations (about one milliwatt), the intensity of sound perceived alongside roads is very high.

The amplification due to the horn effect depends on the tyre and the type of road surface, especially its absorption coefficient.

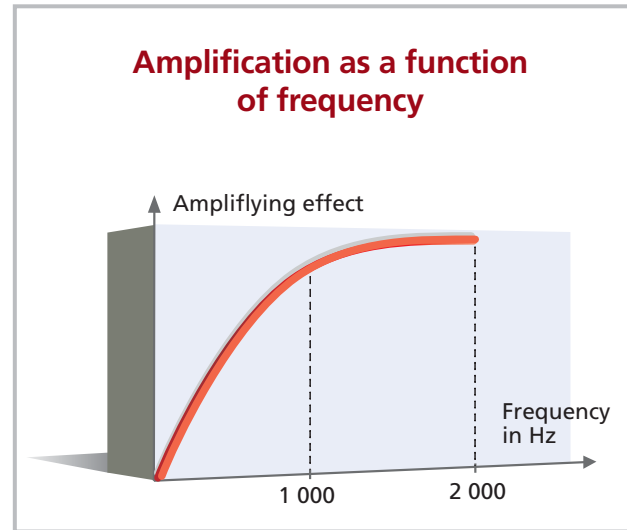



V.4 Effect of tread pattern, construction and width on the level of exterior noise

On the open road, all the mechanisms just studied act simultaneously. They produce noise both inside and outside the passenger cabin. The tyre tread pattern and construction thus affect the level of exterior noise produced when a vehicle passes by. The width of the tyre is also a significant factor. By increasing width, engineers increase the amount of rubber which enters and leaves the contact patch at a given time and hence the acoustic power of most noise-generating phenomena.

The effect of these three parameters - tread pattern, construction and width - depends on operating conditions. The tread pattern of a passenger car tyre strongly affects the noise level at full throttle, for instance, but has less effect at a stable speed. In truck tyres, the construction has more effect at full throttle than at a stable speed.

Relative importance of the effects of tread pattern, width and construction on the level of exterior noise

		At full throttle	Stabilised speed
Passenger car tyre 	Tread pattern	●	●
	Construction	●	●
	Width	●	●
Truck tyre 	Tread pattern	●	●
	Construction	●	●
	Width	●	●

- possible differences of 4 to 6 dB
- possible differences of 2 to 3 dB
- possible differences of less than 1 dB

Note:

these differences cannot be accumulated

Comparison conditions:

- Tread pattern effect: between 2 very different tread patterns (snow - summer) but for 2 tyres of identical size and construction
- Construction effect: between 2 standard tyres of identical size
- Width effect: between 2 tyres with minimum and maximum sizes but from the same line



Effect of road surface on exterior noise

A study conducted by the *Laboratoires des Ponts et Chaussées* (LPC) on French roads showed that the differences in acoustic intensity level from one road surface to another can exceed 9 dB(A) depending on the type of road surface (bituminous concrete, draining mix or surface coating*) and its granularity.

By comparison, for a given vehicle and road surface, it should be remembered that recorded differences between different tyres of the same category (standard tyres, snow tyres, 4-wheel-drive tyres, etc.) rarely exceed 3 dB(A).

The LPC study shows the following trends.

For a given type of road surface, the acoustic intensity level measured increases by about 0.5 dB(A) whenever the **granularity index** increases by 1 mm.

For the same granularity index, **draining mixes** reduce the acoustic level by 3 dB(A), which means the ground absorbs 50% of the sound energy. This can be explained by the fact that draining mixes have a network of voids reaching the surface so as to allow rainwater to drain off. This network allows them to absorb most of the sound waves, unlike classic bituminous concretes whose "closed" surface reflects more than it absorbs.

Effect of road surfaces on the acoustic intensity of passing vehicles,
for an equivalent speed of 90 km/h**

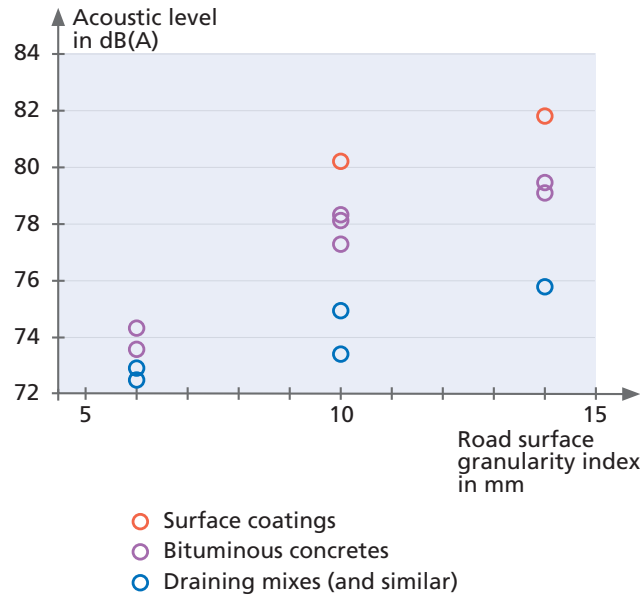

Each circle corresponds to a specific measurement site on the motorway network. Several measurements were taken at each site and then averaged. The **granularity index** corresponds to the maximum size of aggregates used in the road surface.



Measurement conditions:

The maximum acoustic level was measured when vehicles passed, using the "isolated vehicle" method defined by French standard S 31-119 currently in force, i.e. a microphone was placed 7.5 m from the middle of the lane and 1.2 m from the ground, the road being dry. The speed was measured at the same time as the noise so that the measured noise level could be related to the reference speed (90 km/h).

* For more information on road surfaces, refer to p. 24 of the *Grip* booklet, in the same collection.

** Source: ref. [10]

V Mechanisms leading to acoustic disturbance

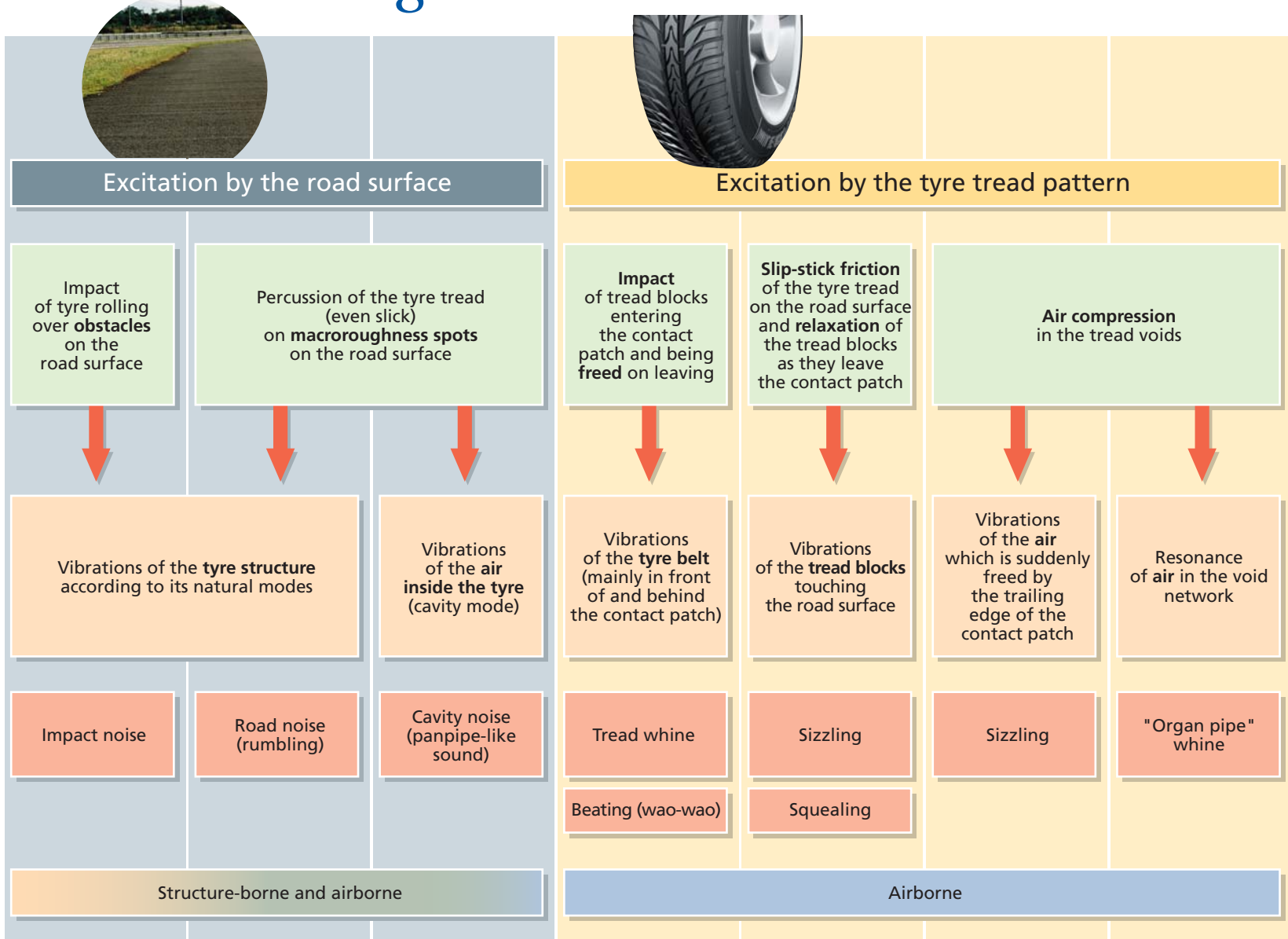
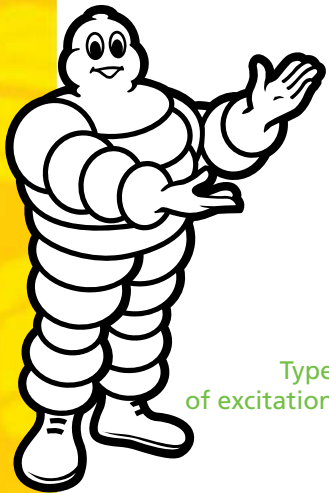

* Noise is also emitted outside the passenger cabin but is not described by type of noise. Only its level is considered, in accordance with current regulations.



VI *Testing mechanical and acoustic comfort*

Before being sold, newly designed tyres must first be tested under actual operating conditions. Mechanical and acoustic comfort tests are performed to guarantee that tyres match user needs.

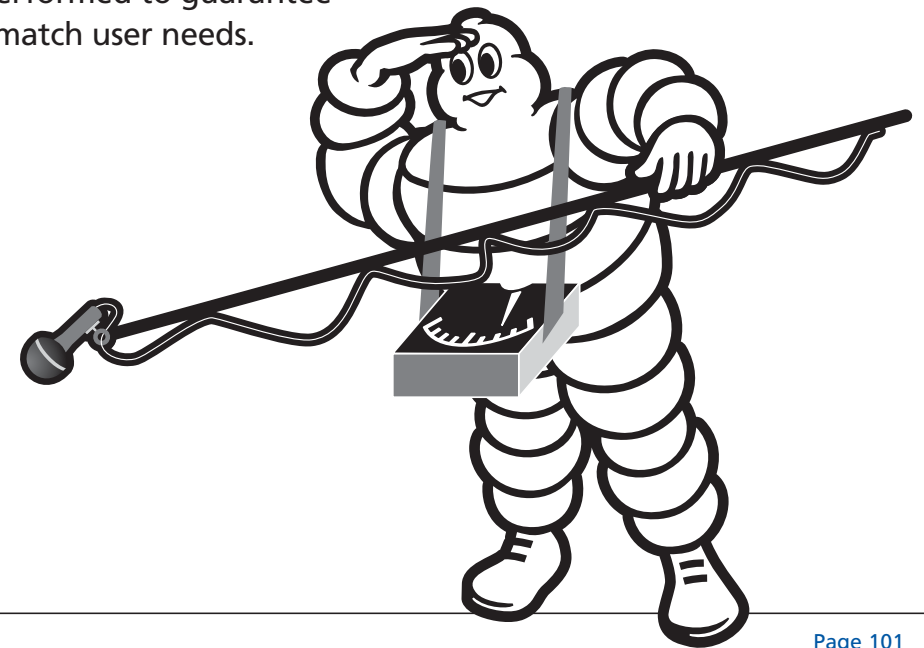

Tyre engineers use **mechanical and acoustic comfort tests to:**

- design tyres which are comfortable for passengers, local residents and bystanders;
- collaborate with car manufacturers to optimise tyre/vehicle coupling;
- certify that vehicles comply with current noise regulations.

Engineers can test mechanical and acoustic comfort in three ways, by:

- taking measurements using analytical test equipment (the vehicle is mounted on a rolling rig)*;
- taking measurements on vehicles fitted with sensors and other instruments and driven on test tracks;
- asking test drivers to assess comfort by rating each type of tyre.

Tests carried out by human beings are of course the most representative of what drivers feel. However, while test drivers can **validate** and **compare** tyres, they cannot identify the causes of any disturbance. In order to **understand** the mechanisms behind discomfort, tyre engineers rely on physical measurements.



Ladoux test tracks at Clermont-Ferrand, France

* During the design phase, measurements are taken on the tyre alone for characterisation purposes. This procedure was described in the section on "Measuring the radial stiffness of a tyre rolling over an obstacle" and "Identifying a tyre's natural modes", chapter III, on pages 44 and 45.

VI.1

Tests on analytical machines

■ IMPACTS DUE TO ISOLATED OBSTACLES (MECHANICAL AND ACOUSTIC COMFORT)

The rolling test rig consists of a drum fitted on a floating platform, which isolates it from any external vibrations transmitted by the ground.

One of the vehicle tyres is rolling on the drum to which rectangular cleats have been attached.

The vehicle is fitted with two accelerometers, one on the vehicle floor by the driver's seat and the other on the steering wheel. A sound meter is also positioned where the driver's right ear would be.

Vibrations and acoustic levels are recorded while rolling at constant speeds between 20 and 100 km/h in 10 km/h steps. Several measurements are taken for each speed. A vibratory index (weighted according to the BSI-defined human sensitivity filters) and an acoustic index (A-weighted) are then calculated.

Rolling rig for mechanical and acoustic comfort tests



Test conditions controlled:

- Tyre pressure
- Load
- Speeds

Values recorded:

- Accelerations along X, Y and Z
- Sound pressure

Values computed:

- Vibration index for each speed
- Acoustic index for each speed
- Vibro-acoustic index by speed interval

MEASURING A VEHICLE'S TRANSFER FUNCTION

Rolling test rigs are also used to measure a vehicle's transfer function.

The transfer function is a mathematical function which calculates the vehicle's capacity to filter or amplify vibrations transmitted to it by the tyre.



A reference tyre is first characterised on its own and then as part of a tyre/vehicle assembly. The two results are compared to compute the vehicle's **global transfer function**. Global transfer function means a function in two parts: one part for overall noise within the passenger cabin, and one for vibrations at pre-determined places in the passenger cabin.

The transfer function is then used to compute the final performance of the tyre/vehicle assembly for new tyres, without taking further measurements on the vehicle.*

This innovative method limits the cost of evaluating the performance of a new tyre to the cost of taking measurements on a tyre alone. Results using this method are obtained about five times faster than for measurements taken in the passenger cabin. Moreover, each vehicle is only needed for a short time.



* Michelin application for patent
WO 01/04589, published on 18-01-2001

Measuring a vehicle's transfer function

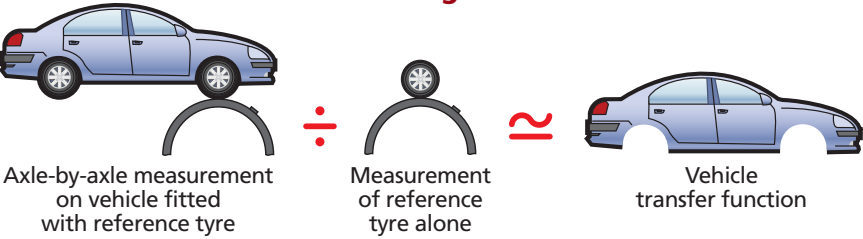

Axle-by-axle measurement on vehicle fitted with reference tyre \div Measurement of reference tyre alone \approx Vehicle transfer function

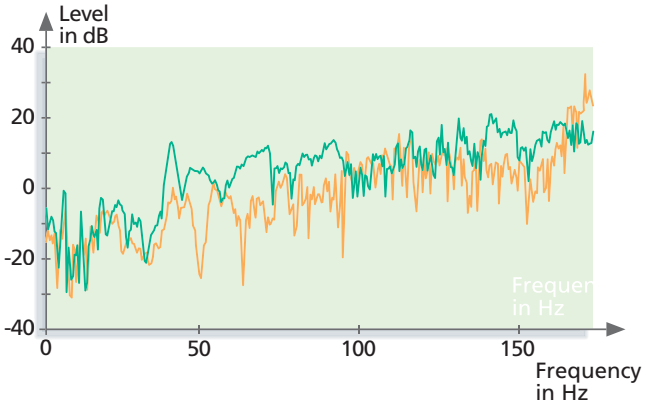

Example of noise transfer functions for two different vehicles

Computing the final performance of a tyre/vehicle assembly

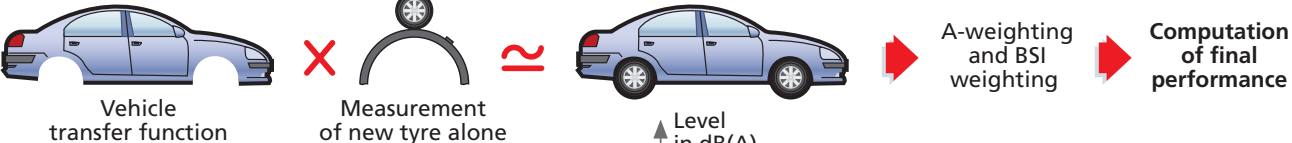

Vehicle transfer function \times Measurement of new tyre alone \approx Vehicle transfer function \rightarrow A-weighting and BSI weighting \rightarrow Computation of final performance

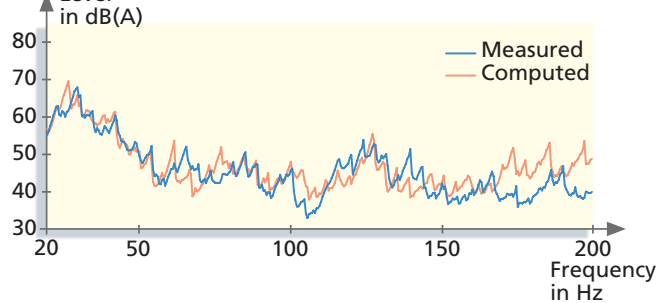

Comparison between measured and computed road noise

■ NOISE INTENSITY MEASUREMENTS

Rolling test rigs are also used to measure tread pattern noise. In this case, the drum surface is smooth (without cleats), and the machine used is installed in a semi-anechoic chamber (or soundproofed room).

A **semi-anechoic chamber** is a room insulated from any source of external noise. Moreover its walls* are lined with non-reflecting structures which prevent echo effects, whence the term anechoic.

A semi-anechoic chamber is used to measure only the noise produced directly by the tyre.

Noise intensity probes are positioned in the form of an ellipse around the tyre. The acoustic intensity emitted by the tyre is measured in W/m^2 .

Sound intensity measurements in a soundproofed chamber

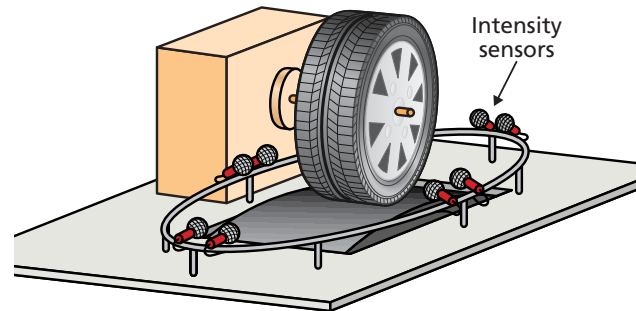

The intensity probes are positioned in the form of an ellipse around the tyre. While a point source emits sound waves in all directions equally, a tyre, due to the shape of the contact patch, emits sound waves according to its elliptical shape.



*A semi-anechoic chamber is a room whose four walls and ceiling are lined with anti-reflecting structures, whereas an anechoic chamber denotes a room whose walls, ceiling **and** floor are lined in this way.

VI.2

Track measurements using test vehicles

SIMPLIFIED MEASUREMENTS OF JOLTING ON BUMPY ROADS

The vehicle is fitted with accelerometers attached to its floor at the front and rear seats. The vehicle is driven at a constant speed (80 km/h) on a bumpy road.

Accelerations are recorded along the X, Y and Z axes over a stretch of road corresponding to 50 seconds of recording. The frequency spectrum of the vibration accelerations is then calculated for each axis.

The vehicle makes several runs.

A BSI-weighted comfort index is then computed for each axis. The indices are then averaged to obtain a front and a rear index.

Test conditions controlled:

- Tyre pressure
- Speed: 80 km/h
- Gearbox ratio (the highest)

Values recorded:

- Accelerations along X, Y and Z

Values computed:

- Front vibration index
- Rear vibration index

A little more information on... 

... calculating RMS and RSS indices

Calculation of RMS values (Root Mean of Squares) for each channel

$$RMS[f_1;f_2] = \sqrt{\int_{f_1}^{f_2} (a_i(f))^2 df}$$

where a_i is the BSI weighted acceleration along the i axis (X, Y or Z)

Calculation of RSS values (Root Sum of Squares)

$$RSS = \sqrt{\sum RMS_i^2}$$

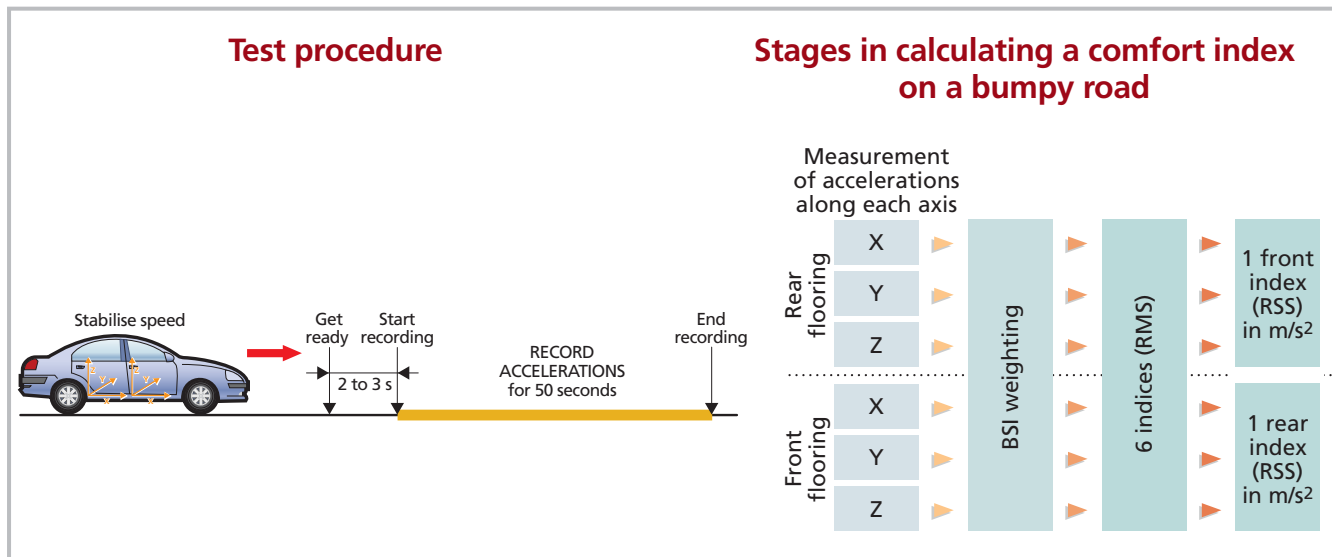

MEASURING NOISE INSIDE THE PASSENGER CABIN: ROAD NOISE AND TREAD PATTERN NOISE

The torso and head of a dummy are installed in the passenger seat. The dummy has a microphone in each ear and a recorder linked to an onboard computer.

The vehicle is driven at a constant speed (80 km/h for instance) on a track whose surface is:

- macrorough, for measuring road noise;
- smooth, for measuring tread pattern noise.

The vehicle makes several runs. For each run, the sound pressure in the cabin is measured for 30 seconds.

For each ear, the frequency spectrum of the sound pressure level is recorded and then corrected using the A-weighting.

An RMS sound pressure index is then computed in dB(A). This index is representative of the acoustic intensity level inside the passenger cabin.



Dummy fitted with a microphone in each ear

Test conditions controlled:

- Tyre pressure
- Speed: 80 km/h

Values recorded:

- Sound pressure

Values computed:

- Frequency spectrum
- Sound pressure level (RMS) in dB(A)



Test procedure

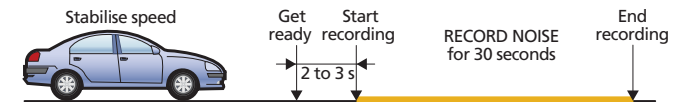

Frequency spectrum of sound pressure level in passenger cabin in A-weighted dB (measurement of road noise).

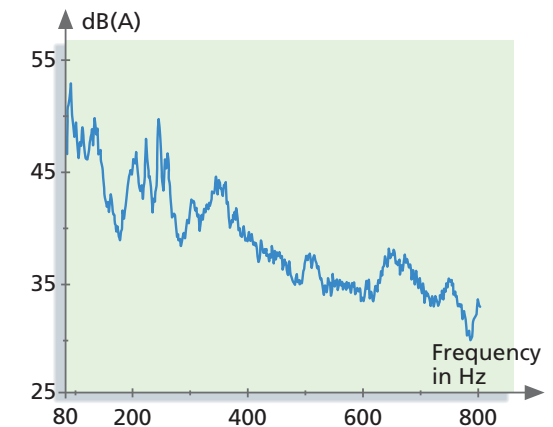

The sound pressure level in the passenger cabin corresponds to the area under the curve. It is calculated as follows:

$$\text{RMS}[f_1;f_2] = \sqrt{\int_{f_1}^{f_2} (X(f))^2 df}$$

where $X(f)$ is the acoustic pressure level in dB(A)/Hz.

VI.3

Test driver assessment of vibration and acoustic discomfort

A test driver assesses and classifies different sets of tyres during the design stage on the basis of criteria that are representative of mechanical and acoustic comfort inside the vehicle.

These tests are also performed to evaluate sets of tyres to meet the particular specifications of car manufacturers.

Each set of tyres is evaluated by comparison with a reference set according to the following procedure:

- drive with reference set;
- evaluate test set 1 by comparison with the reference set (two or three runs);
- drive with reference set;
- evaluate test set 2 by comparison with the reference set (two or three runs);
- and so on.

This means that the order of the runs does not affect the assessment.

The tyres are evaluated on tracks and at speeds selected for each criterion.



Test track with three types of road surface: macrorough, smooth, lane with isolated obstacles.

Cause of the disturbance	Criterion	Type of track	Driving speed
Jolting on bumpy road	Hardness* Damping time	Bumpy road	80 km/h
Impacts due to isolated obstacles	Harshness** Impact noise	Track with isolated obstacles (bumps or hollows)	40 km/h
Macroroughness	Road noise	Macrorough road surface	80 km/h
Tread pattern	Tread whine Beating	Smooth road surface	Slowing down from 110 to 0 km/h to define critical speed
	Sizzling	Smooth road surface	80 km/h

* Magnitude of vertical acceleration felt when rolling over a bump.

** Magnitude of acceleration felt when rolling over a bar or a rut.



Calibration



of test driver perception

The test driver rates the test tyres by comparison with the reference set.
If needed, the test driver can also give a yes/no opinion as to acceptability for each criterion.

In order to make this human evaluation as rational as possible, test drivers are trained to calibrate their grading procedures using reference tyres.

During initial training, the instructors check that the student's rates match their own.

Then, during regular training, each test driver's perception is recalibrated to avoid assessment drifting over time. This is because test drivers might be tempted to exaggerate their perception of differences if they only test tyres with a very similar performance over a long period. In this case, returning to sets of tyres which are known to be very different (training tyres, for instance) enables them to adjust their rating.

Regular training also enables instructors to detect possible perception problems which the test drivers themselves or their colleagues would not otherwise have identified.

VI.4

Regulations on permissible sound levels emitted by motor vehicles

The external noise emitted by a vehicle at full throttle is subject in Europe to European directive 92/97. This directive, outlined below, integrates the methods used for the ISO 362 standard and the R 51 Geneva regulation.*

■ DRIVE-BY TESTS: EUROPEAN DIRECTIVE 92/97

European directive 92/97 defines the conditions for measuring sound levels emitted at full throttle by passenger cars, light trucks and heavy-duty trucks. These measurements are called **drive-by tests**.

Test site**

The measurement takes place in a test zone which covers a 20 m x 20 m square fitted with microphones. The test zone surface is a dense, macrorough bituminous concrete whose characteristics are defined as follows:

- 1- texture depth of surface ≥ 0.4 mm
- 2- either: residual void content $\leq 8\%$
or: sound absorption coefficient ≤ 0.10

The track before and after the test zone is covered with the same bituminous concrete.

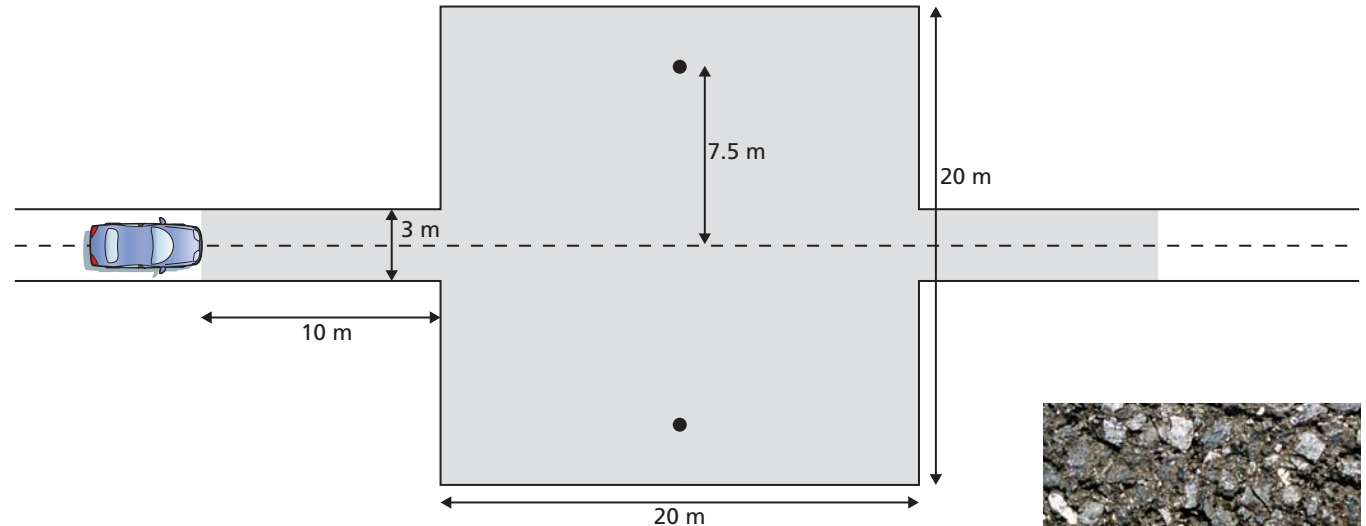

- The microphones are positioned 1.2 metres above ground level.
- Minimum surface covered by the road surface defined by the directive.

Close-up of the road surface defined by the directive



* The so-called Geneva regulations are issued by the Economic Council for Europe (ECE), which is part of the United Nations. These regulations apply to voluntarily participating countries.

** The site defined by the European directive complies with the conditions laid down in the ISO 10844 standard.

Test principle...
... for passenger car tyres*



The test driver reaches the test zone at a speed of 50 km/h, in second or third gear. He then initiates full throttle acceleration and maintains this throughout the test zone.

While the vehicle passes through the test zone, the sound level emitted by the vehicle is measured by the two microphones. The maximum sound level recorded becomes the measurement result for each run.

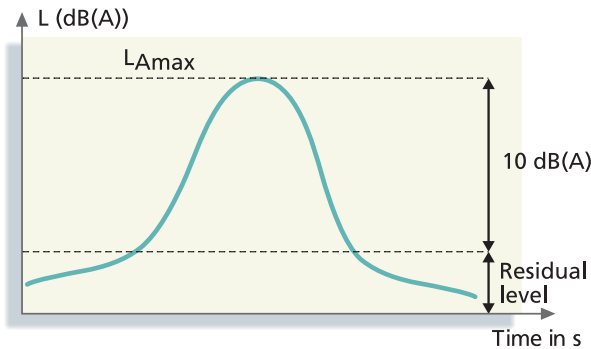

The test driver makes at least two runs in second gear and two runs in third gear. The maximum levels recorded for each run for each gear are then averaged.

To comply with European regulations, these two averages should be such that:

$$\frac{A_{v \text{ maximum level 2nd gear}} + A_{v \text{ maximum level 3rd gear}}}{2} - 1 < 74 \text{ dB(A)}$$

* example for a typical car with 5 manual gears

... for trucks**

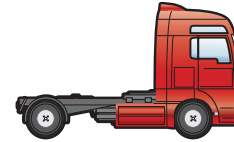

Truck tests are performed using trucks without trailers or semi-trailers.

The test driver drives the vehicle onto the track in order to reach the test zone with a number of rpm equal to $S/2$, S being the number of revolutions for which the vehicle would develop its maximum power for the given gear. He then initiates full throttle acceleration and maintains this throughout the test zone.

The sound level emitted by the vehicle is measured by two microphones. The recording is triggered at the entrance to the test zone and stopped when the vehicle leaves the test zone. The maximum value is retained for each run.

The test driver does at least two runs for each of the gears chosen. The first gear tested ratio is equal to $N/3$, N being the total number of gears. For a truck with 12 gears, the first two runs in this example are done in fourth gear. The last gear tested is the highest ratio for which the engine speed when leaving the test zone is greater than or equal to S (see definition above).

The gear giving the highest noise level is selected for the final result.

In order to comply with European regulations, this result should be such that:

$$\text{Selected measured level} - 1 < 80 \text{ dB(A)}$$

** example for a vehicle with a power greater than 225 kW

Test conditions controlled:

- State of the track: dry
- Ambient sound level: at least 10 dB(A) less than the sound level produced by the vehicle

Test conditions measured:

- Wind
- Temperature

Values recorded:

- Noise level for each run
- Vehicle speed
- Engine rpm

Results selected:

- Passenger car tyre: arithmetic mean of sound pressure levels
- Trucks: maximum value of sound pressure levels

Note:

the methods described here are a simplified summary of the 92/97 directive, which gives slightly different conditions for different types of vehicle. Readers may refer to the directive for more details. [Ref. 8]



The directive stipulates the following maximum values for the different categories of vehicle:

Section	Vehicle category	Maximum permissible result (dB(A))
5.2.2.1.1	Vehicles intended for the carriage of passengers and comprising no more than nine seats, including the driver's seat	74
5.2.2.1.2	Vehicles intended for the carriage of passengers and equipped with more than nine seats, including the driver's seat, and having a maximum permissible mass > 3.5 t:	
5.2.2.1.2.1	- with an engine power < 150 kW	78
5.2.2.1.2.2	- with an engine power ≥ 150 kW	80
5.2.2.1.3	Vehicles intended for the carriage of passengers and equipped with more than nine seats including the driver's seat, vehicles intended for the carriage of goods:	
5.2.2.1.3.1	- with a maximum permissible mass ≤ 2 t	76
5.2.2.1.3.2	- with a maximum permissible mass such that 2 < M ≤ 3.5 t	77
5.2.2.1.4	Vehicles intended for the carriage of goods and having a maximum permissible mass > 3.5 t:	
5.2.2.1.4.1	- with an engine power < 75 kW	77
5.2.2.1.4.2	- with an engine power such that 75 kW ≤ P < 150 kW	78
5.2.2.1.4.3	- with an engine power ≥ 150 kW	80

Evolution of noise emitted by vehicles since 1980

(exterior noise at full throttle)

Over a period of 20 years, the noise emitted by cars has dropped on average by 4 dB(A). Their sound power has thus been divided by 2.3.

Over a period of 20 years, the noise emitted by trucks has dropped on average by 3 dB(A). Their sound power has thus been halved.

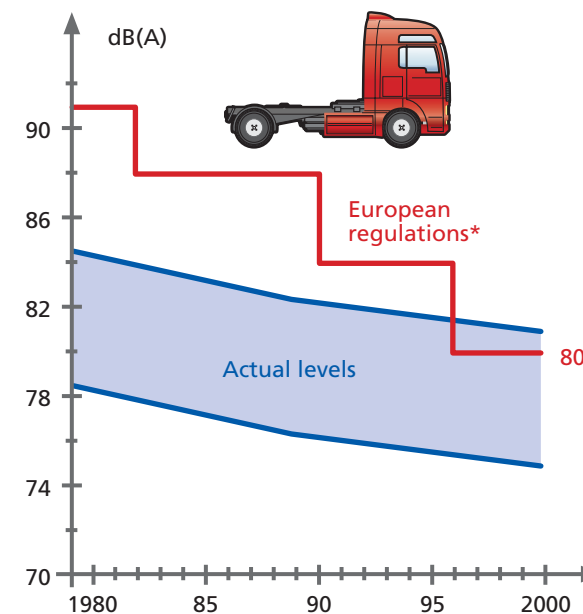
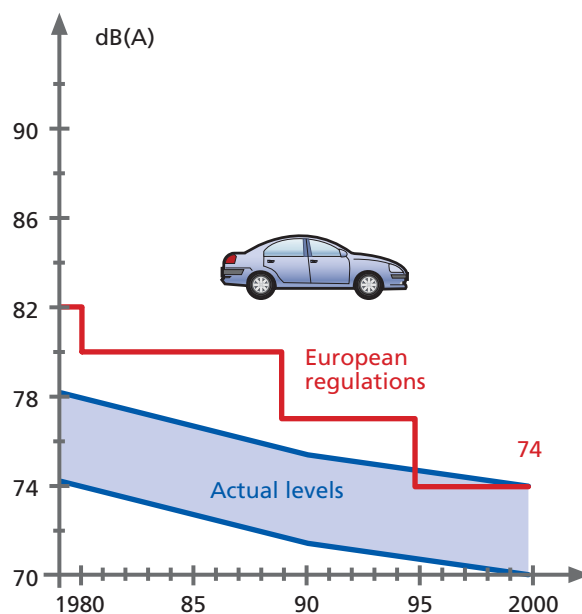

* For trucks over 3.5 t and with an engine power over 150 kW.



The method just described measures the overall noise level emitted by vehicles at full throttle. To know, or at least to estimate, what proportion of vehicle noise is due to the tyres, tyre manufacturers have developed test methods to eliminate, as much as possible, the other noises emitted by the vehicle, especially engine and exhaust noise (it is very difficult to eliminate aerodynamic noise).

To do this, two methods are used:
 - 'soundproofing' the engine and the exhaust;
 - performing tests with the engine off.

DRIVE-BY TESTS USING SOUNDPROOFED VEHICLES

These measurements are taken with a vehicle at full throttle, as described in the drive-by tests above, but on vehicles whose engine and exhaust have been insulated with soundproofing materials.

The tests are used to evaluate the tyre's contribution to the total vehicle noise.

At full throttle, the proportion of tyre noise in vehicle noise can be as high as 50%. However, a given tyre will give different results from one vehicle to another, which is not the case for measurements taken when the car is coasting (engine off).

Vehicles with soundproofed...



... exhaust



... and engine.



Here, the insulated exhaust system has been put inside the vehicle, in the place of the passenger's seat.



Proportion of tyre noise in total vehicle noise at full throttle

Examples of measurement results

Measurement of a typical passenger car

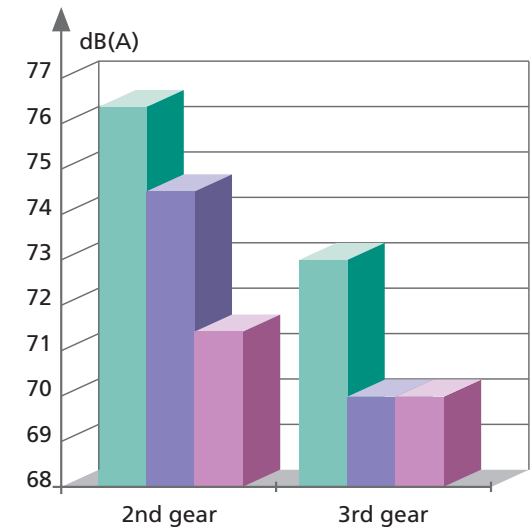
At full throttle, tyre noise represents a third of the total noise in second gear, and half in third gear.



-  1 : Noise measured on vehicles without soundproofing
-  2 : Noise measured on soundproofed vehicles to assess tyre/road surface noise
-  1 - 2 = estimated value of noise due to the vehicle itself





Truck with a soundproofed engine.



Truck whose transmission has been soundproofed with a foam-lined box.

Proportion of tyre noise in total vehicle noise at full throttle

Example of measurement results

Measurement on a small truck

On this truck, the noise of the tyre (and aerodynamic phenomena, greater for trucks than for passenger car tyres) at full throttle represents 32% of the total noise in fourth gear, 50% in fifth gear and 76% in sixth gear.

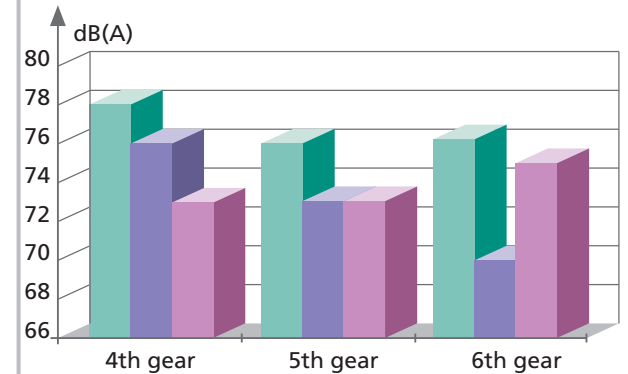

1 : Noise measured on vehicles without soundproofing

2 : Noise measured on soundproofed vehicles to assess tyre/road surface noise

1 - 2 = estimated value of noise due to the vehicle itself

■ A PROJECT TO COMBINE DRIVE-BY AND CRUISE-BY TESTS

In the past, the acoustic disturbance caused by road traffic mainly concerned vehicles accelerating in urban areas (starting from stand-still at traffic lights or stop signs). Today, the greatest disturbance comes from by-pass roads.

The conditions defined by current European regulations (directive 92/97) for measuring vehicle noise are no longer representative of average driving. They correspond to extreme situations at full throttle and it has been observed that the progress measured under these conditions is not found to the same extent in normal operating conditions.

This is why car manufacturers within the EAMA (European Automobile Manufacturers Association) now recommend a new measurement method which is more representative of commonly encountered acceleration levels on roads (commonly 0.1 g under average driving conditions, as against values up to 0.4 g according to the conditions set by the directive).

This new method could include both measurements at full throttle (**drive-by tests**) and measurements at constant speeds (**cruise-by tests**) to better evaluate the progress achieved in noise reduction under average operating conditions.

■ COAST-BY TESTS: NEW EUROPEAN DIRECTIVE 2001/43/CE

New European directive 2001/43/CE defines the conditions for measuring the tyre/road surface noise level of coasting passenger cars, light trucks and heavy trucks.

Even though it will only be implemented gradually according to a predetermined schedule, some tyre manufacturers are already using this kind of test.

Test principle*

The test takes place on the same test site as the drive-by tests described on page 110. The test driver drives the vehicle onto the track in order to reach the entrance to the test zone at a given speed. The vehicle is then put in neutral and the engine is switched off.

The test driver does this at least eight times, at different speeds:

- passenger cars and light trucks: 4 runs at speeds within a 70 to 80 km/h interval and 4 within an 80 to 90 km/h interval;
- heavy trucks: 4 runs at speeds within a 60 to 70 km/h interval and 4 within a 70 to 80 km/h interval.

* Note:

the method described here is a simplified summary of what is stipulated by the directive. The directive defines slightly different conditions depending on the type of vehicle. Readers may refer to it for more details. Ref. [9]. The methods currently used by tyre manufacturers may be slightly different.

Test conditions controlled:

- State of track: dry
- Ambient sound level: at least 10 dB(A) below the sound level produced by the vehicle
- Wind speed and direction (must be < 5 m/s)
- Air temperature ($5 < T_a < 40$ °C)
- Road surface temperature ($5 < T_s < 50$ °C)
- Vehicle in good condition, fitted with 4 identical tyres mounted singly (even for trucks), with windows closed
- Tyres run in over 100 km
- Load should fall within a range centred around 75% of the load capacity index
- Tyre pressure: nominal

Values recorded:

- Noise level at each run
- Speed of vehicle when passing microphones

Values computed:

- Acoustic intensity level in dB(A) related to the reference speed and a temperature of 20°C

A little more information on...



... calculating tyre / road surface noise level with vehicle coasting,

as stipulated by European directive 2001/43/CE

The level of tyre/road surface noise emissions, L_R , before temperature correction is determined by linear regression on the speed, using the following equation:

$$L_R = \bar{L} - \alpha \times \bar{v}$$

where \bar{L} is the mean of the L_i sound levels measured in dB(A)

\bar{v} is the mean of the v_i logarithmic speeds

$$\bar{v} = \frac{1}{n} \sum_{i=1}^n v_i \quad \text{where} \quad v_i = \log\left(\frac{V_i}{V_{\text{ref}}}\right)$$

$V_{\text{ref}} = 80$ km/h for cars and 70 km/h for heavy trucks

n = number of measurements

and α is the slope of the regression line in dB(A)

$$\alpha = \frac{\sum_{i=1}^n (v_i - \bar{v}) \times (L_i - \bar{L})}{\sum_{i=1}^n (v_i - \bar{v})^2}$$

... temperature corrections

as stipulated by European directive 2001/43/CE

Correction for passenger car and light truck tyres:

$$L_{\text{corrected}} = L_R + K(20 - T)$$

where T is the road surface temperature

For passenger car tyres: $K = -0.03$ dB(A)/°C if $T > 20$ °C

or: $K = -0.06$ dB(A)/°C if $T < 20$ °C

For light truck tyres: $K = -0.02$ dB(A)/°C

For heavy truck tyres: no correction.

Final result:

In order to take measurement inaccuracy into account, the result is $L_{\text{corrected}} - 1$ dB(A), rounded down to the nearest whole value.

The sound level emitted by tyre/road surface contact is measured using two microphones. The recording is triggered when the vehicle enters the test zone and stopped when it leaves the test zone.

The level of sound emissions is calculated by linear regression on the speed and then corrected for temperature. The result is expressed in dB(A).

This European directive [Ref. 9] stipulates that the following maximum values are permitted:

- passenger cars: from 72 to 76 dB(A) depending on the tyre's section width;
- light trucks: from 75 to 78 dB(A) depending on the category of use*;
- heavy trucks: from 76 to 79 dB(A) depending on the category of use*.

* normal, snow or special

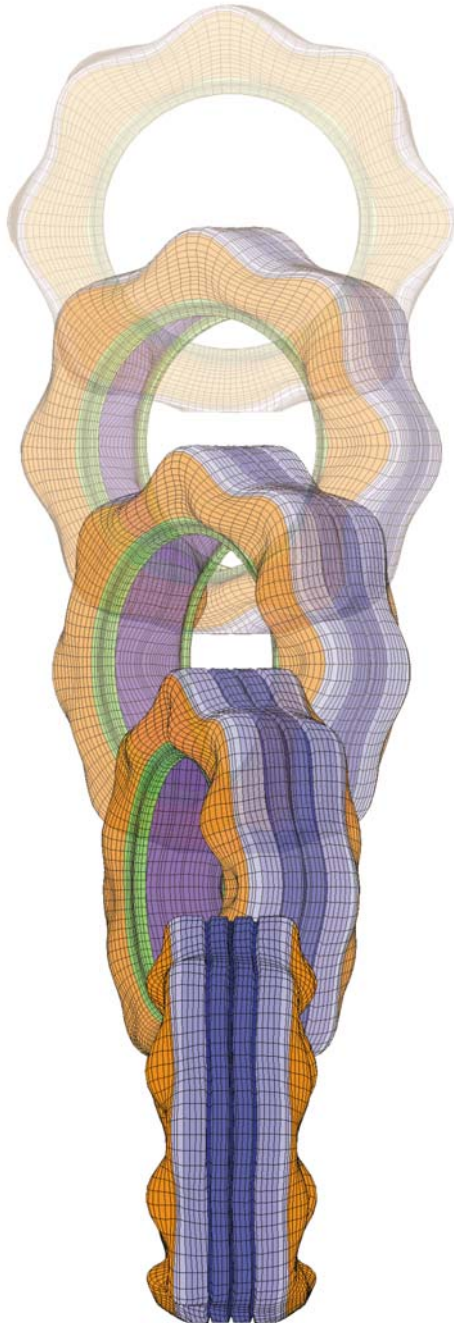

VII *Virtual prototyping*

In the past, tyre design was a lengthy process of trial and error, resulting in high development costs and long lead times.

Today's powerful computers can run design software to simulate quieter, more comfortable tyres before any prototypes are made.

Computer-aided design produces a virtual tyre quite similar to the prototype tyre finally manufactured. Tyres are still thoroughly tested before being sold, but lead times are much shorter.

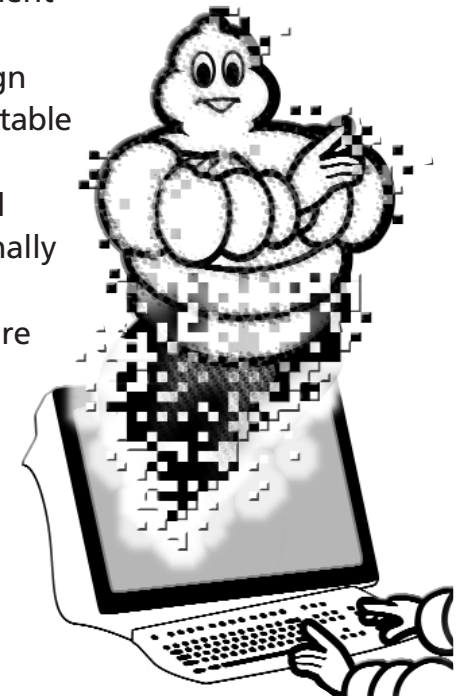

Fifteen years ago, tyre design necessarily required an iterative development loop involving "design - manufacture of prototypes - tests - modifications - manufacture of new prototypes - tests - modifications" and so on until a satisfactory tyre was obtained. Testing was a long and costly process and perfecting a tyre often required several iterations.

Computer-aided modelling has been used for more than thirty years in many fields, such as structural steel work, aircraft manufacturing and space engineering to reduce the number of tests required when developing a new product. However, the simulation of complex structures requires much more powerful computing resources. Unlike steel, which is a homogeneous material subject to slight linear distortion (less than 1%), tyres are complex composites, subject to substantial non-linear distortion (up to 100%). They are very difficult to model as they require an extremely dense mesh structure, and therefore considerable computing power.

Computing power and our knowledge of tyres have progressed apace and the constant efforts made over the last twenty years now make it possible to design more comfortable, quieter tyres quicker.

Computer-assisted tyre design does not start from scratch. Ever since tyres were invented, the know-how built up over the years has been capitalised in the form of state-of-the-art design rules and mathematical models. These guide the engineer to a near-complete, **virtual drawing** which integrates all of the tyre's core functions.

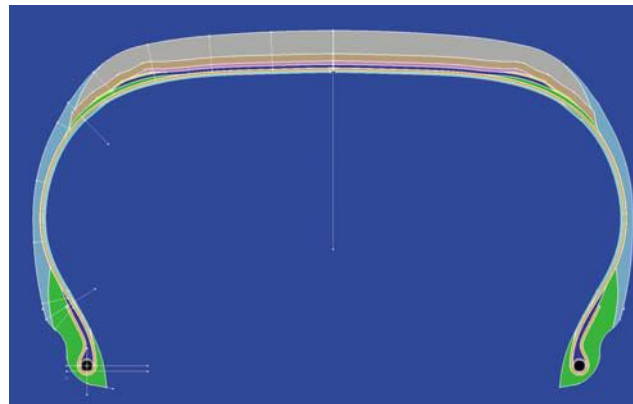

Virtual drawing of a tyre section

Even though this drawing is viable, it still has to be optimised to meet the sometimes very specific needs of manufacturers. Engineers then use finite element analysis to predict the vibratory behaviour of the future tyre.

Just as a wall can be broken down into bricks, the tyre structure can be broken down into small elementary blocks known as finite elements. Each **finite element** has its own physical parameters to describe its behaviour under various stresses (thermal characteristics, density, stiffness, damping qualities, etc.) and the way in which it interacts

Development loop for a new tyre:
Computer-aided prototyping considerably reduces the number of tests performed on actual tyres and optimises performance

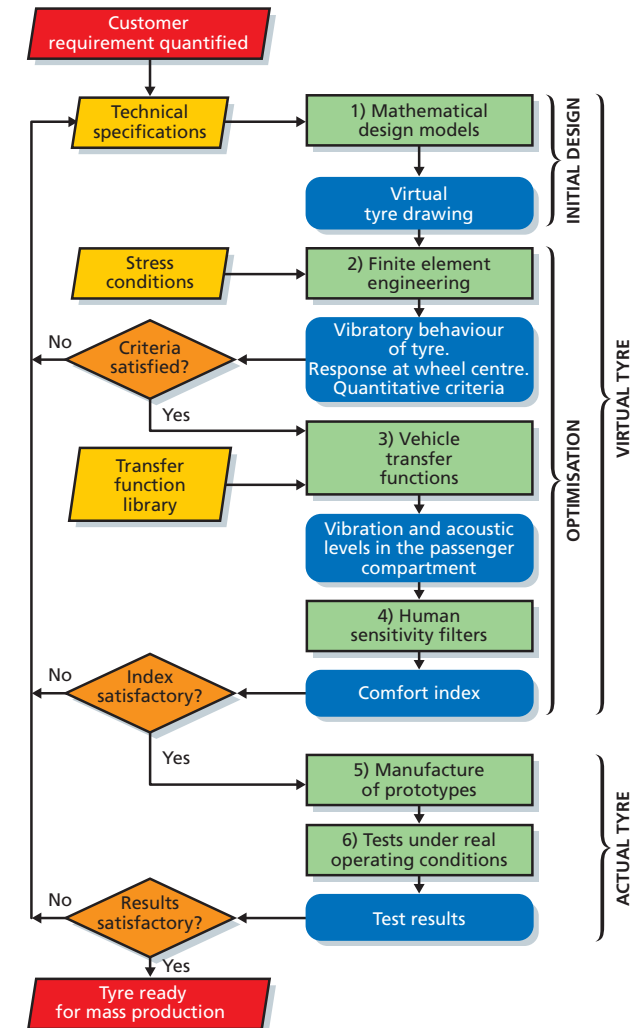

with its direct neighbours. The behaviour of each element is simulated and integrated into a global model giving the general behaviour of the whole structure under various stresses. This requires considerable computing power since the description of a tyre may involve up to 200 000 lines of non-linear equations with 200 000 unknown variables.

Today, finite element modelling is used to compute the **natural vibration modes** of a rolling tyre with an accuracy of $\pm 5\%$ up to 300 Hz. It also computes the forces exerted on the wheel centre when rolling over a geometrically defined obstacle (cleats, rough surface spots), all before even one tyre has been made.

The virtual tyre and the vehicle transfer function, measured according to the method described in chapter VI.1, are then combined to predict vibration and acoustic responses for the passenger cabin of a given vehicle. The modelling method just described continues to be validated by **correlating** the predicted responses and the actual responses of vehicles and tyres. Moreover, work is underway to develop methods for modelling exterior noise.

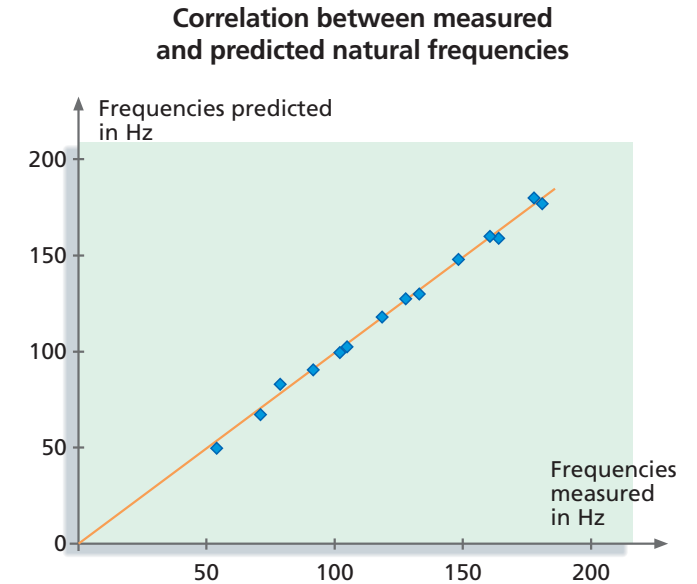
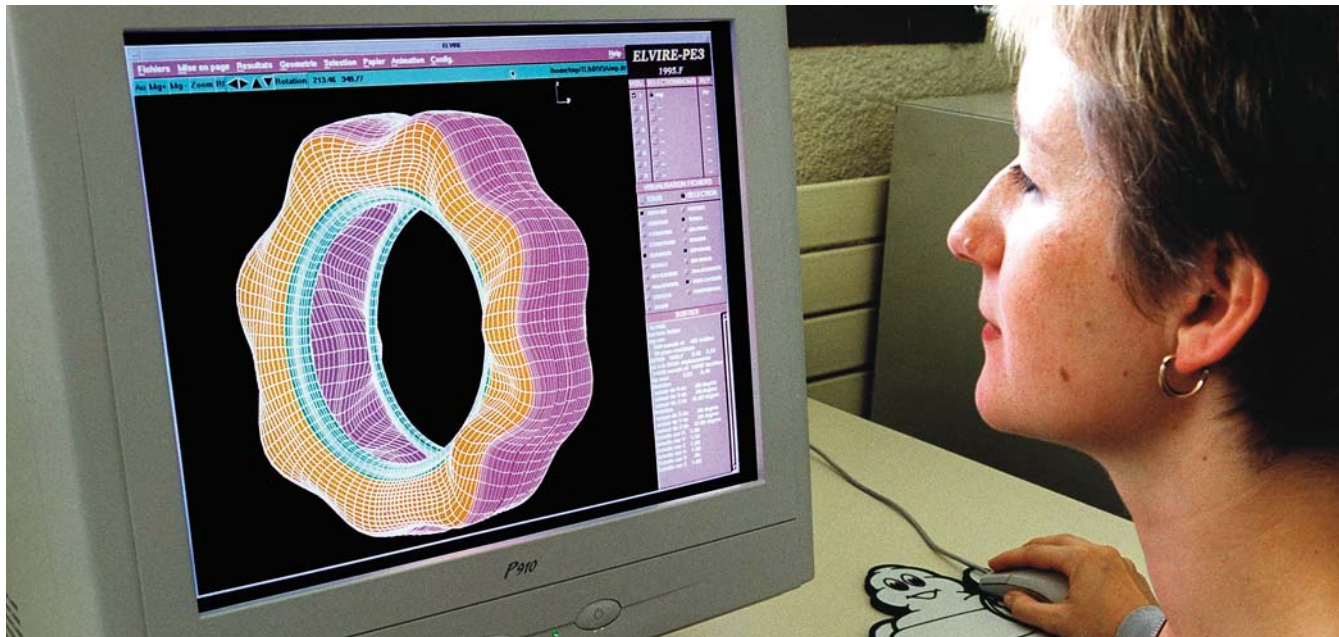

Correlation between measured and predicted values for a tyre rolling over an isolated obstacle

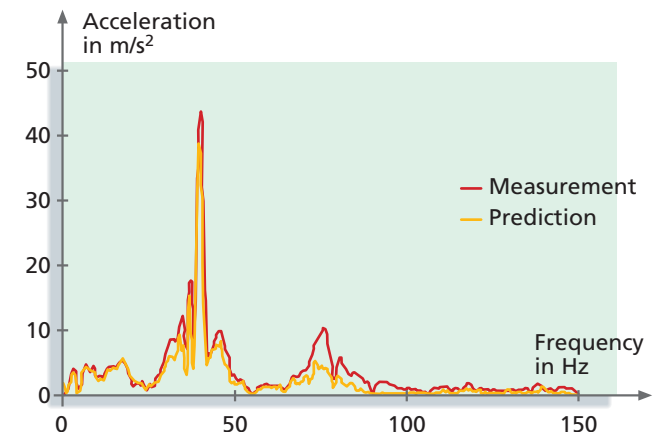

Computer-generated image based on finite element computations. The tyre's natural mode shapes are exaggerated to give engineers a clearer view.

Uniformity verifications during manufacture

Non-uniformities in mass, shape or stiffness of a mounted assembly, all result in a variation of the forces exerted on the vehicle's wheel centre.

Uniformity verifications during manufacture mainly consist in measuring variations in radial and lateral forces, static mass imbalance and radial run-out.

The measuring conditions and machines used are certified. All the parameters mentioned above must lie within specified tolerances for each range of tyres, otherwise the tyres are not released for sale.

MEASURING THE VARIATION IN RADIAL AND LATERAL FORCES

The tyre is mounted on a wheel, inflated then loaded against a drum. While it rolls on the drum, sensors measure variations in the radial forces (along the Z axis) and lateral forces (along the Y axis) being exerted on the centre of the drum.

This gives two temporal signals which can be used to determine:

- the average force (radial or lateral);
- the variation in forces over one tyre revolution: peak-to-peak radial variation (PPRV), or peak-to-peak lateral variation (PPLV);
- the harmonics (RVH1, RVH2, LVH1, LVH2, etc.), used to locate non-uniformities around the circumference more accurately.

Measuring the variation in radial and lateral forces

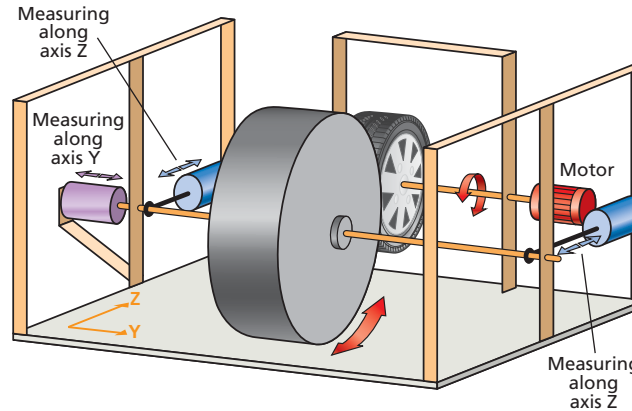

Test conditions: common values

	Passenger car tyre	Light truck
Load	72% of the maximum load applicable	
Pressure	2 bars	3.2 bars
Speed	1 to 3 tyre revolutions per second	

Variation in radial force

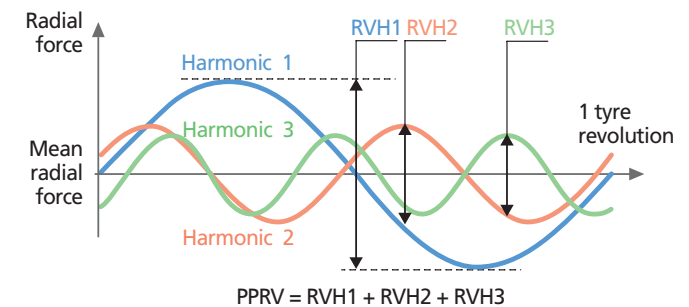
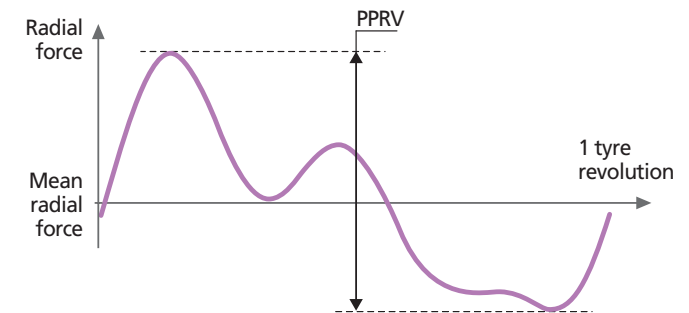

MEASURING STATIC MASS IMBALANCE

The tyre is mounted on a wheel and inflated then placed on an axle fitted with a motor. A sensor measures the variations in vertical forces caused by the tyre's static mass imbalance.

MEASURING RADIAL RUN-OUT AND LATERAL RUN-OUT

The tyre is mounted on a hub and inflated then placed on an axle fitted with a motor. Position sensors measure radius variations (radial run-out) and sidewall position variations (lateral run-out).

Measuring static mass imbalance, radial run-out and lateral run-out

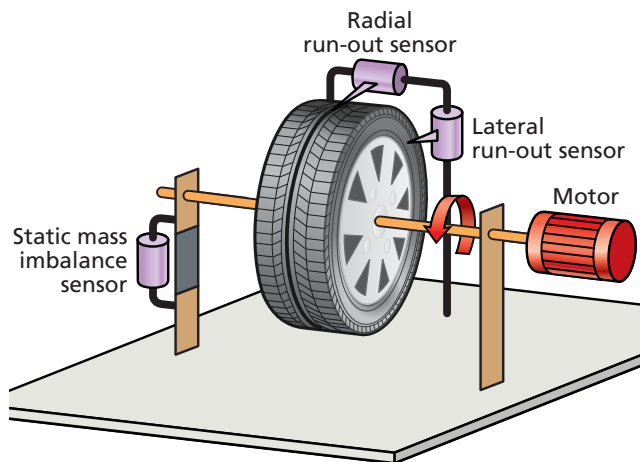

Variations in force: average values

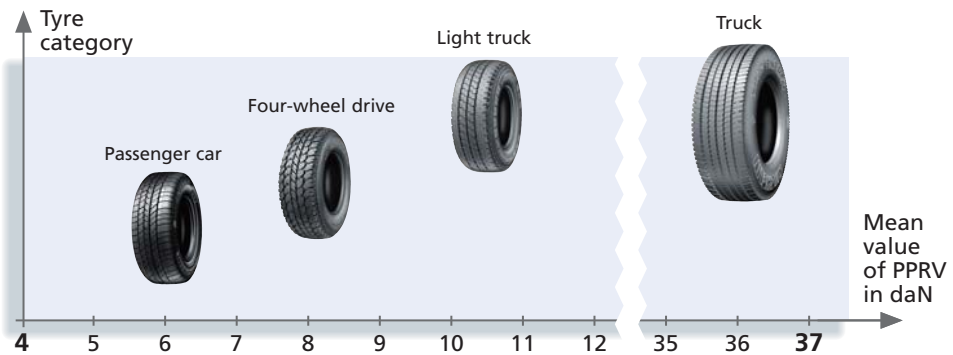
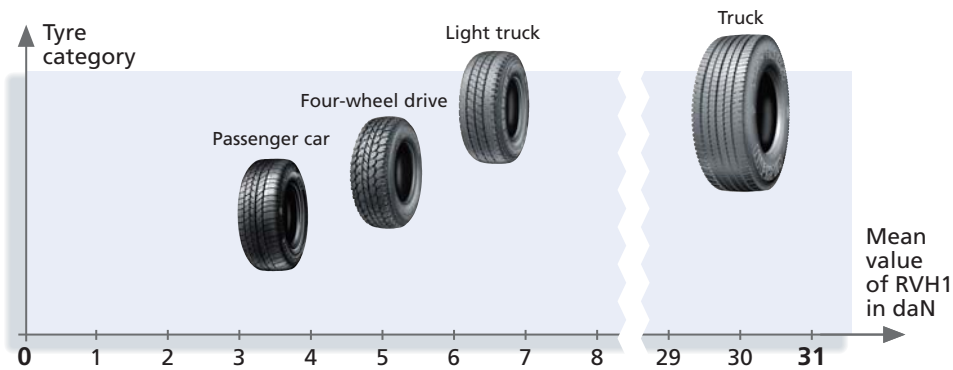

* mass of balancing weights needed to compensate for the tyre's imbalance (in grammes).



A

Acceleration (vibratory ~): pp. 17, 32
Acceleration level: pp. 17, 32
Acoustic comfort: Chap. V
Acoustic disturbance, acoustic discomfort: pp.13, 64, Chap. V, 108, 115
Acoustic intensity, sound intensity: pp. 14, 15, 16
Acoustic intensity level, level of acoustic intensity, sound intensity level, level of sound intensity: pp. 14, 15, 16
Acoustic pressure level: see Sound pressure level
Acoustic vibration: pp. 17, 30, 32, 33, 40, 61
Acoustic wave: see Sound wave
Aggregate: p. 81
Air compression: p. 99
Air pumping: p. 95
Air wedge (see also Horn effect): p. 96
Airborne propagation: pp. 10, 51, 52, 78, 82, 99
Amplification, amplifying effect: pp. 95, 96
Amplitude, magnitude: pp. 17, 20, 21, 27, 28, 30, 32, 38, 60
Amplitude modulation: see Beating
Analytical test equipment, analytical machine: pp. 102, 103
Anechoic chamber: p. 105
Angle of tread grooves, ~ tread bars: pp. 73, 74, 75
Anti-node: pp. 22, 25, 83
Arrangement (Tread pattern ~): pp. 87, 88, 89, 90
Atmospheric pressure: p. 14

Attenuation, attenuate: pp. 15, 33, 35, 37, 38
Auditory sensation: p. 51
A-weighted decibel: see Decibel A
A-weighting: pp. 33, 38

B

Beating, amplitude modulation: pp. 69, 70, 86, 89, 90, 99, 108
Beating frequency: pp. 70, 89
Bel (see also Decibel): p. 14
Bell (Alexander Graham): p. 14
Belt: pp. 85, 86, 99
Bounce resonance: see Rigid-body resonance
Bouncing: pp. 57, 58, 59, 73, 75
Boundary conditions: pp. 25, 26, 45
Bowstring: see String
BSI coefficient: p. 37
BSI weighting: pp. 35, 36, 37
Bumpy road, bumpy ground: pp. 56, 73, 76, 106, 108

C

Cabin interior: p. 40
Car body, vehicle body: p. 40
Cavity noise: pp. 84, 99
Centrifugal effect: p. 65
Circumferential stiffness: p. 41
Cleat: pp 44, 64, 103
Coast-by test: pp. 115, 116
Complex vibration: pp. 19, 28

Compression – decompression: p. 95
Constant speed: see Stabilised speed
Correlation: p. 119
Coupling (~ between the mounted assembly and the vehicle): pp. 64, 80, 83, 84
Cruise-by test (see also Stabilised speed): p. 115
Crystal glass: p. 93

D

Damping: pp. 17, 18, 27, 63
Damping time: pp. 56, 59, 108
Decibel: pp. 14, 17, 27
Decibel A, A-weighted decibel, dB(A): p. 33
Deflection torque: p. 65
Direction of stress: pp. 30, 35, 36
Discomfort: see Disturbance
Disturbance, discomfort: pp. 42, 43
Draining mixes: pp. 83, 98
Drive-by test: pp. 110, 113, 115
Dummy: p. 107
Dynamic couple, dynamic torque: pp. 65, 66
Dynamic imbalance: pp. 65, 66
Dynamic stiffness: pp. 45, 48

E

EAMA (European Automobile Manufacturers Association): p. 115
Earthmover: pp. 56, 73
Elastomer: p. 41
Element size: pp. 86, 87, 88, 90
Engine: pp. 40, 82
European directive 2001/43: pp. 115, 116
European directive 92/97: pp. 79, 110, 111
Exterior noise: pp. 79, 97, 98, 110, 112

F

Farm vehicle: pp. 56, 73, 75
Fechner's law: p. 14
Filter vibrations, vibration filter: Chap. III
Final performance computation: p. 104
Final performance prediction: p. 119
Finite element: p. 118
First cavity mode: p. 84
Flat spot: p. 71
Forced response: pp. 61, 62
Forced vibration: p. 20
Fourier decomposition: p. 19
Fourier transform: pp. 19, 28
Free response: pp. 20, 61, 63
Frequency: pp. 18, 23, 25, 27, 30, 31, 38, 60
Frequency spectrum: pp. 19, 64, 87, 89, 107

Friction: pp. 93, 99

Full throttle (see also Drive-by test): pp. 79, 97, 110, 112, 113, 114, 115

Fundamental, fundamental frequency: pp. 19, 23, 30, 31, 87

G

Granularity index: p. 98

H

Hardness: pp. 56, 108

Harmonic (see also Harmonic composition): pp. 19, 23, 30

Harmonic composition (see also Timbre): pp. 30, 33

Harshness: see Impact harshness

Hertz: p. 18

High-pitched sound (see also Pitch): p. 38

Homogeneous, elastic material: p. 24

Horn effect (see also Air wedges): p. 96

Human hearing range: p. 33

Human perception: pp. 10, 11, Chap. II

Human sensitivity: pp. 30, 33, 35, 38

I

Impact harshness: pp. 61, 108

Impact noise, noise of impact (due to isolated obstacles): pp. 80, 99, 108

Impact of tread blocks: pp. 85, 86, 91, 99

Impacts due to isolated obstacles: pp. 61, 76, 99, 103, 108

Index (comfort ~, vibratory ~, acoustic ~): pp. 37, 103, 106

Inflation pressure: pp. 73, 75

Infrasound: p. 31

Integer mode: pp. 47, 48

Interior noise (see also Exterior noise): p. 79

Isolated obstacles (see also : Impact due to ~): pp. 61, 64, 75, 80, 108

Isolated vehicle method: p. 98

Isosensitivity curve, isosone: p. 33

J

Jolt, jolting: pp. 31, 56, 69, 76, 106, 108



L

Lateral run-out: pp. 67, 71, 122

Level: p. 14

Level of acoustic intensity, level of sound intensity:
see Acoustic intensity level

Level of sound pressure, level of acoustic pressure:
see Sound pressure level

Loader (Earthmoving ~): pp. 73, 74

Local resident: see Nearby people

Localised wear: pp. 67, 71

Loudness: p. 30

Low-pitched sound (see also Pitch): p. 38

LPC (*Laboratoires des Ponts et Chaussées*): p. 98

M

Macroroughness, macrorough: pp. 80, 81, 82, 83, 84, 99, 108

Macrosmooth: pp. 81, 83

Magnitude: see Amplitude

Mass and spring system: p. 60

Mass non-uniformities: pp. 65, 71, 72, 121

Match mounting: pp. 71, 72

Matrix: p. 86

Mechanical comfort: Chap. IV

Mechanical vibration: pp. 17, 30, 32, 40, 51, 61, 69, 82

Microroughness, microrough: pp. 81, 83

Microsmooth: p. 81

Mode shape: pp. 20, 21, 22, 23, 24, 25, 28, 45, 49

Modulation frequency: pp. 89, 90

Modulation rate: pp. 89, 90

Motion sickness: pp. 11, 31, 56

Mounted assembly, tyre and wheel assembly:
pp. 40, 65, 72

Mounting, assembly: pp. 71, 73, 75

N

Natural frequencies of a taut string: pp. 22, 23, 25

Natural frequencies of elastic materials: p. 24

Natural frequencies of sprung masses: p. 60

Natural frequencies of the tyre: pp. 26, 47, 82

Natural frequencies of unsprung masses: p. 60

Natural frequency: pp. 20, 28, 60

Natural mode: pp. 20, 28

Natural mode of engine: p. 40

Natural mode of mounted assembly: p. 40

**Natural mode of rigid-body, of vehicle body,
of sprung masses:** see Rigid-body resonance

Natural mode of vehicle windows: p. 40

Natural modes of a taut string: p. 22

Natural modes of a tyre: pp. 26, 44, 45, 47, 54, 64, 82, 119

Natural modes of elastic materials: p. 24

Natural modes of passenger cabin: p. 83

Natural modes of sprung masses: see Natural mode of rigid-body

Natural modes of unsprung masses: see Wheel hop resonance

Natural modes of vehicles with suspension: p. 57

Natural modes of vehicles without suspension:
p. 73

Nearby people, local residents, passers-by: pp. 51, 52, 79

Node: pp. 22, 23, 25, 83

Noise (see also Sound, Acoustic vibration): pp. 13, 69, Chap. V

Noise of rubber friction on the road surface: p. 93

Non-uniformities: pp. 65, 71, 76

O

Optimisation, optimise: pp. 88, 89, 118

Organ pipe: pp. 95, 99

Overall power, overall level: pp. 79, 86, 87, 91

P

Pascal: pp. 14, 17
Passenger: pp. 51, 52, 79
Passer-by: see Nearby people
Peak: pp. 34, 79, 86, 87, 88, 89
Pendulum: pp. 12, 21
Perception threshold: p. 32
Period: pp. 17, 18
Pitch (of a sound): p. 30
Pitching: pp. 31, 57, 58, 59, 73, 75
Power: p. 34
Prickling sensation: pp. 31, 69
Propagation, propagate (see also Propagation path): pp. 12, 13, 22
Propagation path: p. 51
Propagation speed: pp. 12, 22, 23, 25

Q

Quarter-car model: pp. 57, 60

R

R51 Geneva regulation: p. 110
Radial mode: pp. 44, 46, 47, 64
Radial run-out: pp. 67, 71, 72, 73, 121, 122
Radial stiffness: pp. 41, 44, 59, 62, 64, 68, 73
Reference acceleration: p. 17
Reference acoustic intensity: p. 14
Regulation (see also European directive, Standard): p. 110
Reinforcing: p. 41
Relaxation (of tread block), relax: pp. 93, 99
Remanent image, after-image: pp. 21, 49
Resonance, resonate: p. 20
Resonance frequency: p. 28
Rigid-body motion: p. 57
Rigid-body resonance, bounce resonance, vehicle body resonance, natural mode of sprung masses: pp. 40, 57
RMS (Root Mean of Squares): pp. 106, 107
Road noise: pp. 80, 82, 83, 104, 107, 108, 119
Road surface: pp. 42, 54, 80, 98, 99
Rolling (see also Pitching, Bouncing): pp. 31, 58, 73, 75
Rolling rig: pp. 103, 104
Roughness (road surface ~): p. 81
RSS (Root Sum of Squares): p. 106
Rumble: pp. 83, 99

S

Scramble (sound signal): pp. 87, 88
Semi-anechoic chamber, soundproofed chamber (see also Anechoic chamber): p. 105
Semi-integer mode: pp. 47, 48
Shape non-uniformities: pp. 67, 71, 121
Shock: pp. 12, 31, 61
Simple vibration: pp. 17, 19
Single pitch tread pattern: p. 87
Sinusoidal signal: pp. 18, 19
Sizzling: pp. 93, 94, 95, 99, 108
Slip-stick: pp. 93, 94
Solid tyre: pp. 62, 63
Sound: pp. 10, 13
Sound intensity level: see Acoustic intensity level
Sound pressure level, level of sound pressure: pp. 14, 15, 32
Sound pressure, acoustic pressure: pp. 13, 14, 15, 27, 32
Sound wave, acoustic wave: pp. 13, 14
Soundproofed vehicle: pp. 113, 114
Speed of sound: p. 13
Spring-type behaviour: pp. 44, 54
Sprung masses: pp. 57, 60
Squealing: pp. 93, 94, 99
Stabilised speed, constant speed (see also Cruise-by test): pp. 97, 115



Stagger tyre voids: p. 92
Standard ISO 10844: p. 110
Standard ISO 1683: p. 17
Standard ISO 362: p. 110
Standard S 31-119 (French ~): p. 98
Standing wave: p. 22
Static imbalance: pp. 65, 66, 121
Static stiffness: p. 48
Stiffness non-uniformities: pp. 68, 71, 72, 121
Stressed organ, stressed region: pp. 36, 37, 38
String (~ of a bow, taut~): pp. 12, 18, 21, 22, 23, 24, 25, 26
Structure-borne propagation: pp. 10, 51, 52, 78, 80, 82, 99
Subjectiveness, subjective: pp. 10, 11, 13
Surface coating: p. 98
Suspension: pp. 57, 60

T

Temporal signal: p. 19
Test driver: pp. 108, 109
Test track: pp. 102, 108, 110
Test vehicle: p. 106
Tests: Chap. VI
Thickness of the tread base (in between blocks): p. 91
Threshold of hearing: pp. 14, 32, 33
Threshold of pain: pp. 14, 32, 33
Timbre: pp. 30, 33
Transfer function: pp. 45, 104, 118
Transversal mode: pp. 44, 46, 47, 49

Transversal stiffness: pp. 41, 68
Tread element (see also Element size): p. 86
Tread pattern: pp. 42, 85, 86, 87, 108
Tread pattern adjustment: p. 88
Tread pattern noise: p. 107
Tread whine: pp. 86, 87, 90, 99, 108
Truck: pp. 97, 111, 112, 114, 115
Tyre/road noise: p. 40, Chap. V
Tyre/wheel assembly: see Mounted assembly

U

Ultrasound: p. 31
Unevenness: pp. 56, 58
Uniformity checks: p. 121
Unsprung masses: pp. 57, 60

V

Variable pitch tread pattern: p. 87
Variation in lateral forces: pp. 65, 67, 68, 121
Variation in radial/lateral stiffness: p. 68
Variations in radial forces: pp. 65, 67, 121
Vehicles without suspension: p. 73
Vibration : Chap. I
Vibration in front of and behind the contact patch: pp. 82, 86
Vibration of air inside the tyre: pp. 82, 84, 99
Vibration of the tyre belt: pp. 85, 99
Vibration of the tyre structure: pp. 82, 99

Vibration of the tyre surface, of tread blocks: pp. 42, 50, 94, 99
Vibratory behaviour of the tyre: pp. 42, 44, 54
Vibratory disturbance, vibratory discomfort: Chap. IV, pp. 80, 108
Vibratory wave: pp. 12, 22
Virtual drawing (of a tyre): p. 118
Virtual prototyping: Chap. VII
Visco-elastic: pp. 42, 50, 82
Void angle: p. 92

W

Wao-wao: p. 99
Wavelength: pp. 23, 25, 56, 58
Weighting (see also A-weighting, BSI weighting): p. 33
Wheel balancing: pp. 65, 66
Wheel hop resonance, natural mode of unsprung masses: p. 57
Wheel without tyre: p. 62
Wheel: p. 72
White noise: pp. 34, 87
Width of transversal grooves: p. 91
Windows: p. 40

Bibliography

1. **The tyre, Grip**, Michelin, 2001(same collection), Ed. Société de Technologie Michelin, Clermont-Ferrand, France
2. *British Standard Guide to Measurement and evaluation of human exposure to whole-body mechanical vibration and repeated shock*, BS 6841, 1987
3. *British Standard Guide to Measurement and evaluation of human exposure to vibration transmitted to the hand*, BS 6842, 1987
4. *100 Mots pour Comprendre le Bruit*, Cahier Pédagogique n° 4, Ed. ENEE (Entente Nationale des Elus de l'Environnement), 1994
5. AGATI Pierre, *Mécanique Physique, Automatismes – Aide mémoire*, Ed. Dunod, 1998
6. BURKE HUBBARD Barbara, *Ondes et Ondelettes – La Saga d'un Outil Mathématique*, Ed. Pour la Science, 1997
7. PIERCE John, *Le Son Musical – Musique, Acoustique et Informatique*, Ed. Pour la Science, 1984
8. Council Directive 92/97/EEC of 10 November 1992. Official Journal L 371
9. Directive 2001/43/EC of the European Parliament of the Council of 27 June 2001 amending Council Directive 92/23/EEC relating to tyres for motor vehicles and their trailers and to their fitting.
10. Bulletin des Laboratoires des Ponts et Chaussées, n° 224, janvier-février 2000, *Mesures "au passage" du bruit de contact pneumatique - chaussée : méthodologie, application à l'évaluation des performances acoustiques des revêtements routiers.*

