

SimuLTE – A Modular System-level Simulator for LTE/LTE-A Networks based on OMNeT++

Antonio Viridis, Giovanni Stea, Giovanni Nardini

Dipartimento di Ingegneria dell'Informazione, University of Pisa, Italy

{a.viridis, g.stea}@iet.unipi.it, g.nardini@ing.unipi.it

Keywords: LTE, LTE-Advanced, System-Level Simulator, OMNeT++.

Abstract: This paper describes SimuLTE, an open-source system-level simulator for LTE and LTE-Advanced (LTE-A) networks. SimuLTE is based on OMNeT++, a well-known, widely-used modular simulation framework, which offers a high degree of experiment support. As such, it can be seamlessly integrated with all the network-oriented modules of the OMNeT++ family, such as INET, thus enabling – among other things – credible simulation of end-to-end real-life applications across heterogeneous technologies. We describe the modeling choices and general architecture of the SimuLTE software, with particular emphasis on the MAC and scheduling functions, and show performance evaluation results obtained using the simulator.

1 INTRODUCTION

The Long-Term Evolution (LTE) of the UMTS (3GPP-TS 36.300) is the de-facto standard for next-generation cellular access networks. In an LTE cell, a base station or eNodeB (eNB) allocates radio resources to a number of User Equipments (UEs), i.e. handheld devices, laptops or home gateways, using Orthogonal Frequency Division Multiplexing Access (OFDMA) in the downlink, and Single-Carrier Frequency Division Multiplexing (SC-FDMA) in the uplink. On each Transmission Time Interval (TTI, 1ms), a time/frequency frame of resource blocks (RBs) is allocated to the UEs, in both directions. Each RB carries a variable amount of bytes to/from an UE, depending on the selected modulation and coding scheme. The latter, in turn, is chosen by the eNB based on the Channel Quality Indicator (CQI) reported by the UE, which measures how the UEs perceive the channel. The new Release 10, called LTE-Advanced (LTE-A) (3GPP-TS 36.913), besides promising larger bandwidths due to spectrum aggregation, envisages different transmission paradigms, such as Coordinated Multi-Point (CoMP) Scheduling or device-to-device (d2d) communications.

Resource allocation and management in LTE/LTE-A is a key performance enabler: carefully selecting which UEs to target, using which modulation scheme, etc., clearly affects the efficiency of the system. Moreover, inter-cell interference coordination, cooperative transmission, antenna selection,

resource partitioning among macro and micro-/pico-cells, energy efficiency and battery saving schemes, etc., enable a wealth of declinations of the classical point-to-multipoint LTE scheduling problem. The performance evaluation of resource management schemes for LTE/LTE-A is normally carried out via simulation. This is because – on one hand – testbeds are hardly available, especially to the academia, and – on the other – the entire set of protocols, features and functions of this standard, and their complex interactions, defy any attempt at unified analytical modeling, whereas neglecting or abstracting away some aspects incurs the risk of oversimplification.

Most of the research on LTE/LTE-A is evaluated via home-brewed “disposable” simulators, which are never made available to the community. This makes the claims backed up by such results unverifiable, hence unauthoritative. In the recent past, more structured efforts have been made to provide the research community with reference, open-source simulation frameworks for LTE/LTE-A. Leaving aside physical-layer simulators - e.g., (Mehlfuerer *et al.*, 2009), or (Bouras *et al.*, 2013) - which are outside the scope of this paper, there are three main contributions. The first one is (Ikuno *et al.*, 2010), written in MATLAB, which is limited to the downlink and does not consider some salient aspects of LTE simulation, e.g., realistic traffic generators.

The second one is *LTE-Sim* (Piro *et al.*, 2011), written in object-oriented C++. This includes many more functionalities, such as the uplink, handover,

mobility, UDP and IP protocols, several schedulers and some traffic generators (e.g., VoIP, CBR, trace-based, full-buffer). This simulator, however, comes with some limitations. Hybrid ARQ (H-ARQ) seems not to be supported. Moreover, scenarios are written as static C++ functions. Thus, they are hard to verify for correctness, and they are compiled together with the simulator. Mixing models, scenarios, and experiment definition in a simulator is hardly desirable from a software engineering standpoint. The main drawback of *standalone* simulators such as the above two is that they are costly to extend and not interoperable. Even granting a state-of-the-art code structure, they force users to invest an often unreasonable time into modeling, coding and verifying any extra functionality, an effort which is seldom reusable. For instance, the current release of LTE-Sim lacks TCP. The effort required to develop the code to run a web-browsing simulation on LTE-Sim (e.g., to back up a claim in a scientific paper) entails modeling TCP, HTTP, server, content, and user behavior, and is probably large enough to discourage most scientists. The same can be said for the setup of a WiFi-core-LTE simulation scenario. Moreover, these simulators offer no support to *simulation workflow automation*. This includes, ideally, the ability to define parametric scenarios, to manage multiple repetitions with independent initial conditions, to define and collect measures, to efficiently store, retrieve, parse, analyze and plot simulation results, etc. The lack of such instruments (and the ensuing need to make up for it with home-brewed, error-prone or however unstructured solutions) is a major cause of delay and errors in simulation studies, especially large-scale ones, as shown in (Perrone *et al.*, 2009, Kurkowski *et al.*, 2005).

A third contribution has been realized within the framework of *ns-3* ([ns3-homepage](http://www.isi.edu/ns3), 2014). *ns-3* is being developed by a large community of scientists with heterogeneous research interests, and it already includes a considerable number of network modules (e.g., WiFi, WiMAX, 802.11s mesh networks, etc.). The *ns-3* LTE simulator (Baldo *et al.*, 2011), henceforth *ns-3-LTE* for want of a better name, is an ongoing effort, which has been designed to allow end-to-end simulation with realistic traffic models. It includes both the Radio Access Network and the Evolved Packet Core. Recently, the SAFE (Simulation Automation Framework for Experiments) framework has been released, providing functionalities for planning, control and result storage of experiments in *ns-3* (Perrone *et al.*, 2012). However, the SAFE project – still ongoing at the time of writing – appears to require a non-trivial effort on the user side to be integrated with *ns-3*.

Our contribution is a new LTE simulator, called SimuLTE, which has been developed for the OMNeT++ simulation framework (Varga *et al.*, 2008) and

has been released under LGPL at <http://www.simulte.com>. We chose OMNeT++ for several reasons: first, it is a stable, mature and feature-rich framework, much more so than *ns-3*. It was released in 2001, with the explicit goal of automating as many steps of the simulation workflow as possible, so as to enable large-scale simulation studies and bridge the gap between writing down models and getting credible results. Second, it is perfectly modular, which made it easy to write all the required code from scratch, and makes it easy to extend it. Third, it already includes a large amount of simulation models, e.g. INET (<http://inet.omnetpp.org/>), which boasts an impressive protocol matrix, all the TCP/IP stack, mobility, wireless technologies, etc.. Thanks again to the modular structure, this allows users to simulate *mixed* scenarios, of which LTE/LTE-A constitutes only one part, and get a feeling of the true end-to-end performance of simulated applications. Fourth, OMNeT++ has a smooth learning curve: novice users can exploit graphic interfaces to setup and run fairly complex scenarios in no time, while advanced users may exploit a structured topology-definition language (NED, Network Description). Last, but not least, it is supported by a large and active community of users, from both academia and networking industries, which is a guarantee that any setup time invested in learning the ropes can be amortized over a long future.

SimuLTE simulates the data plane of the LTE Radio Access Network and Evolved Packet Core. It consists of over 40,000 lines of code (i.e., roughly double as many as LTE-Sim, which however also factors in many extra functionalities, e.g. mobility, applications, IP/UDP, event queues, etc., which we instead took from the OMNeT++ kernel and INET). In this paper, we describe its modeling approach and show some non-trivial results that can be obtained with it regarding resource allocation. As for the modeling, besides giving a high-level description, we focus on the modeling approaches that differ from those of the other simulators. Specifically, the 3GPP-compliant H-ARQ functionalities – which are not described in other simulators – are introduced in some detail. Furthermore, we detail the scheduling model, which is based on *virtual schedulers*, which can be run concurrently and then be chosen among by an allocator. As for performance evaluation, we profile the simulator execution time in several scenarios, we show how scheduling heuristics for multi-band resource allocation problems fare against the optimum, and we highlight results related to multi-cell environments which defy analytical modeling.

The rest of the paper is organized as follows. Section 2 describes the OMNeT++ framework. Section 3 provides an overview of SimuLTE. We show some SimuLTE validation in Section 4 and performance

results in Section 5. Finally, Section 6 concludes the paper and outlines future work.

2 THE OMNeT++ FRAMEWORK

SimuLTE is based on the OMNeT++ simulation framework, which can be used to model several things – i.e., not only networks. We focus only on the aspects of OMNeT++ which are more relevant to understanding SimuLTE. The interested reader is referred to <http://www.omnetpp.org> for more details.

The basic OMNeT++ building blocks are *modules*, which can be either *simple* or *compound*. Modules communicate through *messages*, which are usually sent and received through a *connection* linking the modules' *gates*, which act as interfaces. A *network* is a particular compound module, with no gates to the outside world, which sits at the top of the hierarchy. Connections are characterized by a bit rate, delay and loss rate, and cannot bypass module hierarchy: with reference to Figure 1, simple module 3 cannot connect to 2, but must instead pass through the compound module gate. Simple modules implement model behavior. Although each simple module can run as an independent coroutine, the most common approach is to provide them with event handlers, which are called by the simulation kernel when modules receive a message. Besides handlers, simple modules have an initialization function and a *finalization* function, often used to write results to a file at the end of the simulation. The kernel includes an event queue, whose events correspond to messages (including those a module sends to itself).

OMNeT++ allows one to keep a model's *implementation*, *description* and *parameter values* separate. The implementation (or *behavior*) is coded in C++. The description (i.e., gates, connections and parameter definition) is expressed in files written in Network Description (NED) language. The parameter values are written in initialization (INI) files. NED is a declarative language, which exploits inheritance and interfaces, and it is fully convertible (back and forth) into XML. NED allows one to write *parametric* topologies, e.g. a ring or tree of variable size. NED files can be edited both textually and graphically (through a Graphic User Interface, GUI), switching between the two views at any time. INI files contain the values of the parameters that will be used to initialize the model. For the same parameter, multiple values or intervals can be specified.

As far as coding is concerned, OMNeT++ comes with an IDE, derived from Eclipse, which facilitates debugging. In fact, modules can be inspected, textual output of single modules can be turned on/off during

execution, and the flow of messages can be visualized in an animation, all of which occurs automatically. Events can be logged and displayed on a time chart, which makes it easy to pinpoint the causes or consequences of any given event.

As for workflow automation, OMNeT++ clearly separates *models* (i.e., C++ and NED files) from *studies*. Studies are generated from INI files, by automatically making the Cartesian product of all the parameter values and, possibly, generating replicas of the same instance with different seeds for the random number generators. Note that the IDE allows one to launch and manage multiple runs in parallel, exploiting multiple CPUs or cores, so as to reduce the execution time of a simulation study. Finally, data analysis is rule-based: the user only needs to specify the files and folders she wants to extract data from, and the *recipe* to filter and/or aggregate data. The IDE automatically updates and re-draws graphs when simulations are rerun or new data become available. The performance of OMNeT++ has been compared to that of other simulators, notably ns-3, (Weingartner, 2009). The result is that the two are comparable as for run time and memory usage, with ns-3 faring marginally better within the limits of the analyzed scenarios.

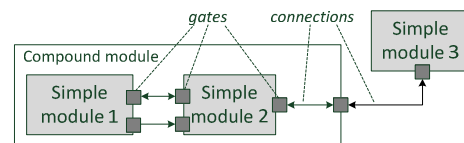

Figure 1: OMNeT++ module connection.

3 Overview of SIMULTE

SimuLTE simulates the data plane of the LTE/LTE-A Radio Access Network and Evolved Packet Core. Due to lack of space, we assume that the reader is familiar with the LTE architecture (a table of acronyms is reported in the Appendix for ease of reference), and we only describe the RAN modeling. SimuLTE allows simulation of LTE/LTE-A in Frequency Division Duplexing (FDD) mode, with heterogeneous eNBs (macro, micro, pico etc.), using omnidirectional and anisotropic antennas, possibly communicating via the X2 interface. Realistic channel models, MAC and resource scheduling in both directions are supported. In the current release, the Radio Resource Control (RRC) is not modeled.

The general structure of the three main nodes is shown in Figure 2. SimuLTE implements eNBs and UEs as compound modules. These can be connected with each other and with other nodes (e.g. routers, applications, etc.) in order to compose networks. The Binder module is instead visible by every other node

in the system and stores information about them, such as references to nodes. It is used, for instance, to locate the interfering eNBs in order to compute the inter-cell interference perceived by a UE in its serving cell. UE and eNB are further composed of modules. Every module has an associated description file (.ned) defining its structure, and may have a class definition file (.cpp, .h) which implements the module functionalities.

The UDP and TCP modules, taken from the INET package, implement the respective transport layer protocols, and connect the LTE stack to TCP/UDP applications. As Figure 2 shows, TCP and UDP applications (*TCP App* and *UDP App*) are implemented as vectors of N modules, thus enabling multiple applications per UE. Each TCP/UDP App represents one end of a connection, the other end of which may be located within another UE or anywhere else in the topology. SimuLTE comes with models of real-life applications (e.g., VoIP and Video on Demand), but any other TCP/UDP-based OMNeT++ application can also be used. The IP module is taken from the INET package as well. In the UE it connects the *Network Interface Card (NIC)* to applications that use TCP or UDP. In the eNB it connects the eNB itself to other IP peers (e.g., a web server), via PPP (Point-To-Point Protocol).

The NIC module, whose structure is shown in Figure 3, implements the LTE stack. It has two connections: one between the UE and the eNB and one with the LTE IP module. With reference to Figure 3, each of the NIC submodules on the left side represents one or more parts of the LTE protocol stack, which is common to the eNB as well. The only module in the UE that has no counterpart in the eNB is the *Feedback Generator*, which creates channel feedbacks that are then managed by the PHY module. In the following we describe each sub-module with their related functionalities. We will use *downstream* and *upstream*, respectively, to identify the flow of traffic from an upper to a lower layer within the same module and vice-versa, and *downlink* and *uplink* for the traffic flow from the eNB to the UE and vice-versa.

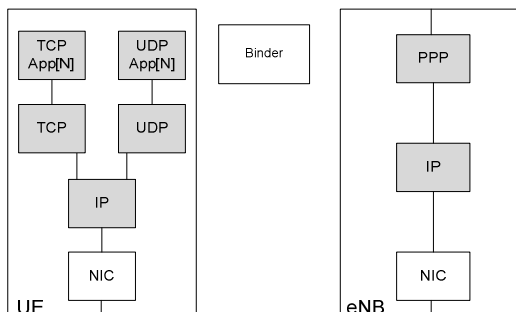

Figure 2: UE and eNB module structure. Greyed modules are taken from the INET framework.

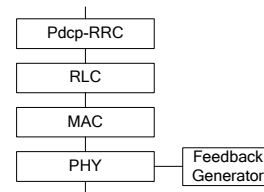

Figure 3: NIC module architecture on the UE.

3.1 PDCP-RRC module

The PDCP-RRC module is the connection point between the NIC and LTE-IP modules. The PDCP-RRC module receives data from upper layers in the downstream direction and from the RLC layer in the upstream. In the first case it performs RObust Header Compression (ROHC) and assigns/creates the Connection Identifier (CID) that uniquely identifies, together with the UE ID, a connection in the whole network. A Logical Connection Identifier (LCID) is kept for each 4-tuple in the form $\langle \text{sourceAddr}, \text{destAddr}, \text{sourcePort}, \text{destPort} \rangle$. When a packet arrives at the PDCP-RRC module, the correct LCID is attached to it (if there exists one), otherwise a new one is created storing the new 4-tuple. Then, the packet is encapsulated in a PDCP PDU and forwarded to the proper RLC port, depending on the selected RLC mode, as described in Section 3.2. In the upstream, a packet coming from the RLC is decapsulated, its header is decompressed and the resulting PDCP PDU is sent to the upper layer.

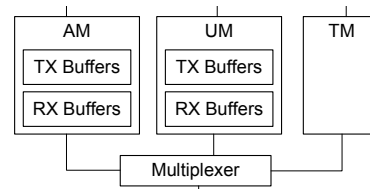

Figure 4: RLC module representation.

3.2 RLC module

The RLC module performs multiplexing and demultiplexing of MAC SDUs to/from the MAC layer, implements the three RLC modes *Transparent Mode (TM)*, *Unacknowledged Mode (UM)* and *Acknowledged Mode (AM)* as defined in (3GPP-TS 36.322), and forwards packets from/to the PDCP-RRC to/from the proper RLC mode entity. RLC operation is the same on both the eNB and the UE.

The structure of the RLC module is shown in Figure 4. There are three different gates connected with the PDCP-RRC module, one for each RLC mode. The TM submodule has no buffer, as it forwards packets transparently, while AM and UM have their own set

of transmission/reception buffers, one for each CID associated to that RLC mode.

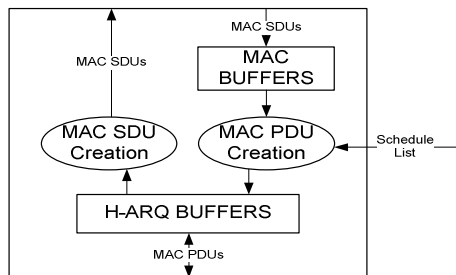

Figure 5: MAC packet flows.

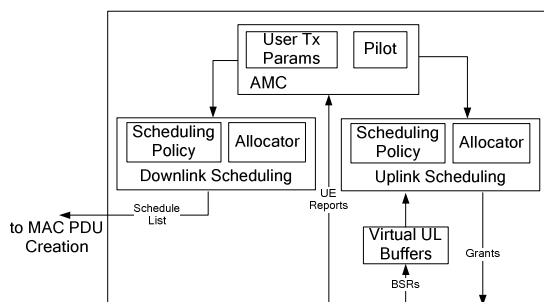

Figure 6: MAC Scheduling Operation.

3.3 MAC module

The MAC module is where most of the intelligence of each node resides. Its main tasks are buffering packets from upper (RLC) and lower layers (PHY), encapsulating MAC SDUs into MAC PDUs and vice-versa, managing channel feedback, adaptive modulation and coding (AMC) and scheduling. Those operations are the same at the UE and the eNB, with scheduling and channel-feedback management being the only exceptions. The high-level structure of the MAC is shown in Figure 5. In the downstream, MAC SDUs coming from the RLC layer are stored in *MAC Buffers*, one for each CID. On each TTI some connections are scheduled for transmission, according to the schedule list composed by the scheduler. MAC SDUs from the scheduled connections are then encapsulated into MAC PDUs, which are then stored in the H-ARQ buffers and forwarded to the physical layer. The detailed structure of H-ARQ buffers will be explained later on. In the upstream, MAC PDUs coming from the physical layer are stored into H-ARQ buffers. They are then checked for correctness, decapsulated and forwarded to the RLC.

The entities involved in eNB scheduling are shown in Figure 6. Resource scheduling is performed at the eNB for both the uplink and the downlink. For the uplink, decisions are notified to the UEs via *grant*

messages, i.e., in the current release the Physical Downlink Control Channel (PDCCH) is not directly simulated. Each UE reads the grants and decides which local connection will be able to use the granted resources, if any. UEs in turn request uplink resources via the *Random Access* (RAC) Procedure, which is again implemented through messages generated by the MAC module. The Physical Random Access Channel (PRACH) is not directly simulated. In order to properly make scheduling decisions, both downlink and uplink schedulers need the status of user connections and the channel quality perceived by each UE. The downlink connection status is inferred directly from MAC buffers, while in the uplink the status is inferred from *virtual uplink buffers*. The latter are kept synchronized with the real MAC buffers on the UE side via Buffer Status Reports (BSR), as defined in (3GPP - TS 36.321), which are control elements attached to uplink transmissions.

The Adaptive Modulation and Coding (AMC) entity stores channel status information from the UE reports, deciding (*Pilot* entity) and storing (*User Tx Params* entity) transmission parameters such as modulation and coderate, and computing the amount of bytes per resource block for each user based on those parameters, as defined in (3GPP - TS 36.213).

As far as H-ARQ is concerned, *Transmission* and *Reception H-ARQ Buffers* (from now on *TxBuff* and *RxBuff*) store MAC PDUs that are being sent and received respectively. This means that a MAC PDU is stored therein until it is received correctly or the maximum number of retransmissions is reached. Reception is notified via H-ARQ feedback messages. H-ARQ buffers on the eNB maintain MAC PDU information for each connected UE in both downlink and uplink, for each H-ARQ process and for each codeword (hence, these modules require no modification to support Single-User MIMO). The general structure shown in Figure 7 is valid for both Tx- and Rx-Hbuffs, hence we will use the neutral *Hbuff* to denote both. A *Hbuff* contains K buffers, one for each active connection to another node. Hence an eNB has as many buffers as connected UEs in each direction, whereas a UE has up to one per direction, as it communicates directly only with its serving eNB. Each buffer contains N *processes* ($N=8$, usually), one per H-ARQ process. Finally, each *Process* contains two *Units*, to support SU-MIMO. A *Unit* contains the information related to a transmitting/receiving MAC PDU. The status of the *Unit* is stored in a different manner on TX- and RX-buffs as it depends on the feedback management procedure. The finite state automata for transmission is represented in Figure 8 (the one for reception is similar, *mutatis mutandis*). ACK and NACK are the reception of the corresponding H-ARQ feedback. *TxCount* is the transmission counter, increased in the SELECTED state and reset

in the EMPTY one. MAX_TX is the maximum number of transmissions before discarding a PDU.

The hierarchy of eNB schedulers is shown in the left part of Figure 9. The *eNB Scheduler* base class implements operations that are common to the DL and UL, such as data structures initialization, allocation management via the Allocator, and statistics collection. The two classes *eNB Scheduler UL* and *DL* extend the base class by implementing the `rtxSchedule()` method, which manages retransmissions. In addition the *eNB Scheduler UL* manages RAC requests.

At the beginning of each TTI the eNB prepares a *schedule list* in each direction, which shares available resources among the active connections, according to a given *policy*. This is performed by a member of the eNB Scheduler called *Scheduling Policy*. Its main function, `schedule()`, consists of two steps: first, the scheduling policy is applied on a set of *virtual connections*, without modifying MAC buffers; then the decisions are stored and passed to the MAC, which enforces them by fetching the data from its buffers and constructing the PDUs (see again Figure 6). The scheduling policy builds the schedule lists by repeatedly polling the Allocator for given amounts of bytes transmitted at the CQI of the connection being examined. This allows one to envisage general schedulers, that decide *both* the priority order of connections *and* the amount of data to be scheduled from each: for instance, schedulers that only serve *urgent* data from each connection (instead of attempting to empty each queue sequentially), or set fixed quanta.

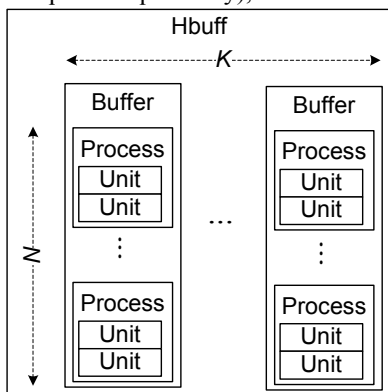

Figure 7: Common *Hbuff* structure.

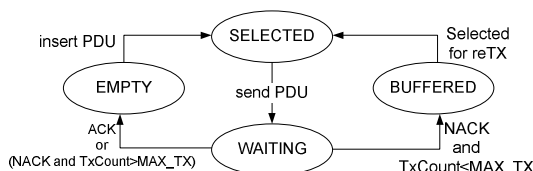

Figure 8: Finite State Automata for Unit status in TX.

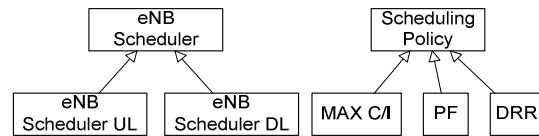

Figure 9: eNB schedulers and Sch. Policy hierarchy.

The fact that scheduling occurs in two steps allows a user, among other things, to run multiple schedulers in parallel, choosing which schedule list to commit among a set of alternatives. The Scheduling Policy hierarchy is shown in the right part of Figure 9. To implement a new scheduling policy, a developer only needs to implement the two steps of the `schedule()` function. Three well-known scheduling policies are included in the current release, namely *Maximum Carrier-over-Interference* (Max C/I), *Proportional Fair* (PF), *Deficit Round Robin* (DRR). Finally, we observe that scheduling policies may redefine the `rtxSchedule()` function. Retransmissions can be scheduled either at a higher/lower priority than first transmissions, or jointly with them.

3.4 PHY module

The PHY module implements functions related to the physical layer, such as channel feedback computation and reporting, data transmission and reception, air channel emulation and control messages handling. It stores the physical parameters of the node, such as the transmission power and antenna profile (i.e., omni-directional or anisotropic). This allows one to define *macro-micro-, pico-eNBs*, with different radiation profiles. Each physical module on the eNB and the UE has an associated Channel Model C++ class that represents the physical channel as perceived by the node itself. The Channel Model is an interface that defines two main functions: `getSINR()`, which returns the *Signal to Interference plus Noise Ratio* (SINR), and `error()`, which checks if a packet has been corrupted. We describe the current implementation of the channel model later on, but one can easily implement its own model by implementing the Channel Model interface.

On the UE side, some tasks related to physical layer procedures are performed by an independent *Feedback Generator* module. This module generates channel feedback (i.e., CQIs), which can be configured to be periodic or aperiodic. Furthermore, CQIs can be either wideband or per-sub-band: in the latter case, the user can configure the number of sub-bands and of reported CQIs. The feedback generation process exploits the function provided by the Channel Model interface. Note that the physical LTE channels, such as the *Physical Downlink Control Channel*

(PDCCH), *Physical Uplink Control Channel* (PUCCH) and *Physical Random Access Channel* (PRACH) are not modeled down to the level of OFDM symbols, to keep both memory and CPU usage limited. Their functionalities are instead implemented via control messages sent between the eNB and UE nodes. Any limitation of those channels, (e.g., on the maximum number of UEs that can be scheduled simultaneously on the PDCCH), can nevertheless be emulated by imposing constraints on the messages themselves.

In the downstream, MAC PDUs are received from the MAC layer and encapsulated in an *Air Frame* packet. Packets are marked with a *Type*, i.e. *data* or *control*, then they are directly sent to their destination module, selected according to the control information attached to the packet. In the upstream, a received Air Frame packet is selectively processed depending on its type: control packets are directly forwarded to the upper layer (assuming correct reception), whereas data packets are tested against the `error()` function of the Channel Model before being marked and sent to the upper layer.

Our implementation of the Channel Model interface is called *Realistic Channel Model*. The SINR is computed as $SINR = P_{RX}^{eNB} / (\sum_i P_{RX}^i + N)$, where P_{RX}^{eNB} is the power received from the serving eNB, P_{RX}^i is the power received from the interfering eNB i , N is the Gaussian noise. Furthermore, P_{RX} is computed as $P_{RX} = P_{TX} - P_{loss} - F - S$, where P_{TX} is the transmission power, P_{loss} is the path loss due to the eNB-UE distance (which depends on the frequency), and F and S are the attenuation due to *fast* and *slow* fading respectively (Jakes, 1975). The above operations are performed within the `getSINR()`, on a per-RB basis. This allows one to simulate the effects of interference on every single RB, e.g. taking into account the transmissions from neighboring eNBs, so as to evaluate LTE-A interference-coordination mechanism such as the Enhanced inter-cell interference coordination (eICIC) or Coordinated MultiPoint (CoMP). The `error()` function compares the CQI used for transmitting a packet with the one computed at the moment of reception. An error probability P_{err} is then obtained by using realistic BLER curves and the two previously computed CQIs. A uniform random variable $X \in [0,1]$ is sampled and the packet is assumed to be corrupted if $X < P_{err}$, and correct otherwise.

The choice of the channel model usually arises strong feelings among scientists and practitioners in wireless networks. For this reason, besides proposing one, we took care of implementing it in an easily modifiable way. Modifications can be done in either of the following ways:

- extend the base *LteChannelModel* class, and specifically implement the two functions

`getSINR()` and `error()`. This requires some work, but allows maximum flexibility.

- Modify our *Realistic Channel Model*, and specifically the functions for computing pathloss, fading and shadowing. This requires minimal modifications, at the price of less flexibility.

Note that, whichever the choice, the rest of the code is obviously unaffected.

4 VALIDATION

Validating the tons of data produced by a simulator is a very common problem. One possible approach is to compare these values against measurement obtained from real systems. Unfortunately, to the best of our knowledge, none of these measurements are publicly available. Another possible solution, as suggested in (Zhou *et al.*, 2013), is to compare simulation results with theoretical ones obtained in simple reference scenarios. We thus choose a single cell in two scenarios: a single-user one (*scenario I*) and a multi-user one (*scenario II*). In both cases UEs are static and measurements are made at distances to the eNB ranging from 500 to 2000 meters. In *scenario II* UEs are placed within a 50m-radius circle centred at the specified distance. The main simulation parameters are described in Table 1.

Table 1: Simulation parameters.

Parameter	Value
N_{PRB}	25
Pathloss model	ITU-R, Rural Macro
Mobility model	Stationary (OMNeT++ model)
eNB Tx Power	30 dBm
Noise figure	5 dB
Cable loss	2 dB
Distance eNB – UE	500, 1000, 1500, 2000 m
Simulation time	2 seconds

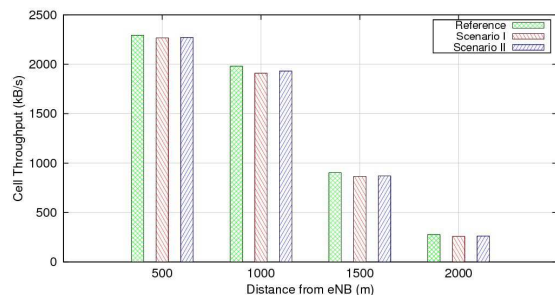

Figure 10 - Cell Throughput for Scenario I and Scenario II compared against theoretical reference throughput.

We compare the throughput of the simulated scenarios against a reference throughput obtained as $T_{pt} = S(MCS, N_{PRB})/\tau$ (Zhou *et al.*, 2013) where τ is the duration of a TTI (i.e. 1ms), $S(MCS, N_{PRB})$ is the transport block size for the measured CQI and for N_{PRB} physical resource blocks.

As we show in Figure 10, simulation results match the reference ones, in both scenarios. Note that the results obtained with distances greater than 500m are not directly comparable with the ones of the above work, as the two pathloss models are different.

5 PERFORMANCE EVALUATION

This section presents three contribution. First, we show how the simulation times varies with the number of UEs and cells and with the traffic profile. Second, we show that inter-cell interference increases the number of allocated RBs in a cell in a way which analytical formulas fail to predict. Finally, we formulate the MaxC/I scheduling problem in a multi-band setting as an optimization problem, we show to solve it optimally by interfacing SimuLTE and CPLEX, and we use it to benchmark a simple heuristic.

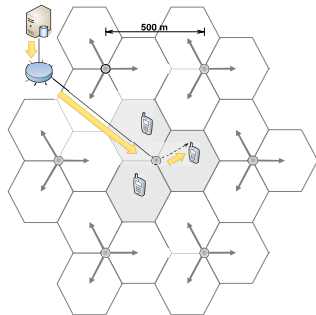

Figure 11: Simulation scenario.

5.1 Profiling of execution time

We setup a scenario with a varying number of UEs and cells. eNBs use anisotropic antennas, radiating at 120° angles and transmitting at 46dBm, and employ MaxC/I scheduling. The simulation scenario is shown in Figure 11, where each circle represents a cluster of three co-located cells. CQIs are wideband and reported periodically. The UM RLC is employed, and the MAC fragment is set to 20 bytes. The overall amount of available RBs is 50. UEs are uniformly distributed among cells and receive VoIP traffic (40-byte application packets on each 20ms, with alternated talkspurts and silences), which is generated by a server and forwarded to the eNBs through a router. 20s of the above system are simulated on an Intel(R) Core(TM) i7 CPU at 2.80 GHz, with 8 Gb of RAM, a

Linux Ubuntu 12.04 operating system, and OM-NeT++ version 4.2.2. Each run is repeated five times in independent conditions. 95% intervals are displayed unless negligible.

Figure 12 reports the running time for three, nine and 21 cells. The latter depends almost linearly on the number of UEs in all cases. Increasing the number of cells influences the overall running time, as computing interference requires more operations.

In the scenario with nine cells, Figure 13 shows how the simulation time depends on the traffic profile: we vary the packet size and the period, while keeping the same application-layer bitrate. However, Figure 14 shows that the MAC-level per-UE bitrate is quite different, due to the protocol overheads. In particular, the MAC PDU size is 33 bytes larger than the application packet (header compression is not used). In Figure 13, bottom, mid and top markers on each curve are for 30, 60, and 90 UEs, respectively. For the same MAC-layer offered load (i.e., the same abscissa), smaller packets sizes require shorter simulation times. However, for the same number of UEs (i.e., the same group of markers), the simulation time depends on the *number* of transmitted packets, hence a smaller packet size (i.e., more packets per unit of time) implies longer simulation times.

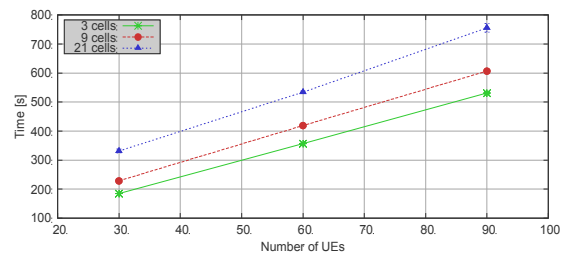

Figure 12: Execution time with varying number of cells.

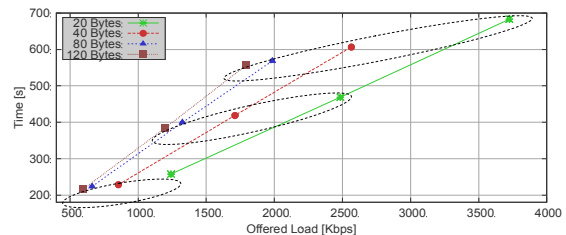

Figure 13: Execution time with varying offered load.

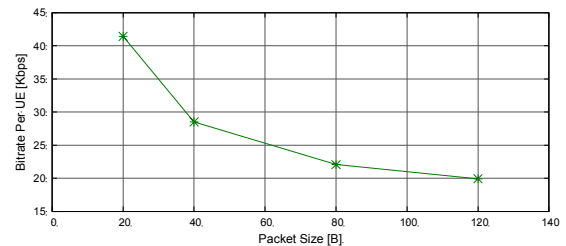

Figure 14: Bitrate per UE at MAC level.

5.2 Inter-cell interference

SimuLTE allows in-depth analysis of the effects of the inter-cell interference. We consider three co-located cells as in Figure 13. UEs receive CBR traffic at a rate of 0.2 Mbps. Figure 15 reports the average number of RBs allocated by a cell. We compare the results with those obtained by using the formula in (Fantini *et al.*, 2011), using the same channel model in both cases. The formula evaluates the interference based on the probability that two cells use the same RB, given the amount of RBs allocated by the two cells and assuming that each cell picks its RBs at random in the frame. Since the interference depends on the allocated RBs and vice versa, the formula is updated until it reaches a steady state. We note that there is a point (at 65-70 UEs) where the simulative curve has a step. This happens because the more a cell fills its own frame, the more it generates interference on UEs of neighbouring cells, which in turn report lower CQIs. Accordingly, neighbouring cells need to allocate more RBs to serve their UEs, thus producing additional interference that further decreases CQIs and causes retransmissions. Moreover, transmissions may occur simultaneously on RBs with low and high interference. Since wideband CQIs are used, high-interference RBs may be corrupted, causing retransmission, hence even more allocated RBs. At low loads, the system is still able to satisfy the additional requests, whereas at high loads this results in a positive feedback that rapidly drives the system towards saturation. This effect cannot be observed using the analytical formula because it does not account for the impact of errors and retransmissions.

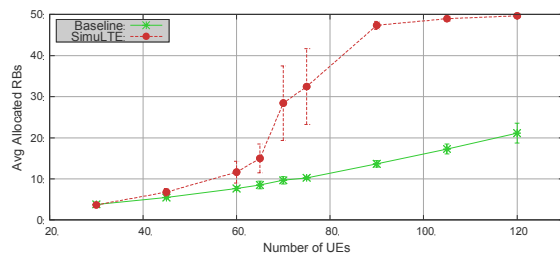

Figure 15: Average allocated RBs per cell.

5.3 Multi-band scheduling

Many resource allocation problems in LTE/LTE-A can be formulated as optimization problems. Hereafter, we describe a typical one, and we show how to interface SimuLTE with optimization solver CPLEX to solve it, believing this to be useful to researchers working in this area, for both the results and the way we obtained them.

MaxC/I scheduling is a relatively simple problem if we assume wideband CQIs and a number of trans-

mitted bytes which is linear with the number of allocated RBs, with the CQI representing the line slope. In fact, in this case, all it takes to obtain the maximum throughput is to allocate enough RBs to empty the queue of each UE, in decreasing order of CQI (taking some extra care when padding is involved). Therefore, MaxC/I scheduling can be obtained at a complexity of $O(N \log N)$, N being the number of UEs. When per-sub-band CQI are used, however, obtaining the maximum throughput becomes an NP-hard problem, as shown in (Accongiagioco *et al.*, 2013), hence some heuristics are used to obtain suboptimal solutions. Recall that a UE can use *one* CQI in a TTI (typically, the minimum of all the CQIs in the sub-bands where it is allocated some RBs). The maximum throughput problem can be formulated as follows:

$$\begin{aligned}
 & \max \sum_{i=1}^N \left(r_i \cdot \sum_{j=1}^M x_{i,j} - p_i \right) \\
 \text{s.t. } & \sum_{j=1}^M \left(r_i \cdot \sum_{j=1}^M x_{i,j} - p_i \right) \leq Q_i \quad \forall i \quad (i) \\
 & p_i \leq r_i - 1 \quad \forall i \quad (ii) \\
 & r_i \leq CQI_{i,j} + (1 - b_{i,j}) \cdot CQI_{\max} \quad \forall i \quad (iii) \quad (1) \\
 & x_{i,j} \geq b_{i,j} \quad \forall i, j \quad (iv) \\
 & \sum_{i=1}^N x_{i,j} \leq B_j \quad \forall j \quad (v) \\
 & r_i, p_i \in \square^+ \quad \forall i \quad (vi) \\
 & b_{i,j} \in \{0, 1\}, x_{i,j} \in \square^+ \quad \forall i, j \quad (vii)
 \end{aligned}$$

where M is the number of sub-bands, each one of which having B_j RBs. r_i is the rate that will be used by UE i (assumed to be a number of bytes per RB), $CQI_{i,j}$ is the CQI of UE i in sub-band j (translated to a number of bytes per RB as well), p_i and Q_i are the padding and queue length for UE i . $b_{i,j}$ is a binary variable that is equal to 1 if UE i is allocated RBs in sub-band j , and $x_{i,j}$ is the number of RBs that it has allocated in that sub-band.

The above one is a mixed integer-non-linear problem, which can be linearized using standard enumeration techniques and solved through CPLEX (which only solves *linear* problems). Therefore, we can use the optimal solutions to benchmark heuristics, provided that we interface SimuLTE and CPLEX. There are two ways to do so: one is to use its C++ API, which requires integrating it into Eclipse and learning to use it, both being non-trivial. The other, which we chose, is to manage files via `tmpfs`, i.e., save files in volatile memory: while this is less efficient, it only requires one to be able to write down a scheduling problem in the LP file format used by CPLEX (which is very intuitive) *and* to write a parser for SOL CPLEX output solution files, which are XML-based.

At each TTI, we do the following: first we obtain the constants, i.e., queue size, per-sub-band CQIs, etc.

Then, we generate an LP file describing the linearized problem. The problem is then solved by invoking CPLEX with the LP file as an input. The resulting SOL file can be easily parsed via xml-related functions given by the `omnetpp` environment. Figure 16 shows a snippet of the output file that defines the final allocation: each line specifies the *name* of a variable ($x_{i,j}$, in this case) and its *value*, i.e. the number of RBs allocated to user i within sub-band j . Finally the allocation is enforced in the simulated system and the rest of the operations for the TTI are executed.

The multi-band MaxC/I heuristic that we choose to benchmark is the following: we sort all UEs by decreasing *sum of per-sub-band CQIs*, and we allocate enough RBs to empty their queue (as if multiple CQIs could be used simultaneously). Then we use the minimum CQI among the selected sub-bands. We compare the above solutions in a scenario with six RBs, a number of UEs ranging from 10 to 75, and VoIP traffic. Both solutions achieve the same throughput, since the system is still far from saturation conditions, but the heuristics uses up to 30% more RBs, as shown in Figure 17.

```
[...]
<variable name="x4_1" [...]value="1"/>
<variable name="x4_2" [...]value="1"/>
<variable name="x4_3" [...]value="1"/>
<variable name="x4_4" [...]value="1"/>
<variable name="x4_5" [...]value="1"/>
<variable name="x5_0" [...]value="1"/>
[...]
```

Figure 16: Snippet of CPLEX XML output file.

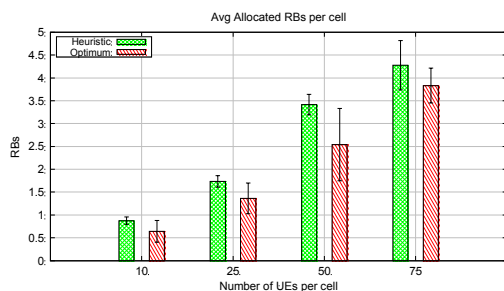

Figure 17: RB occupancy comparison between the heuristic and optimum solutions.

5 CONCLUSIONS

This paper described SimuLTE, an open-source LTE/LTE-A simulator based on the OMNeT++ framework. The current release supports the data plane of the radio access network, with a full protocol stack, a realistic physical layer and scheduling capa-

bilities. We have described the modeling approach in detail, especially focusing on the MAC and resource allocation models. Moreover, we have shown some examples of performance evaluation that can be obtained through SimuLTE.

There are several directions in which this work can be extended, most of which are being pursued at the time of writing:

- The initial validation provided in Section 4 is to be expanded. Our contributions in this direction will be presented in future works.
- As anticipated in the Introduction, there are other LTE simulators available for the public domain. A comparison of SimuLTE against these is on the agenda. We expect this comparison to reinforce validation, to provide insight regarding the different features and capabilities of the simulators, and to benchmark their efficiency.
- The LTE-A technology is evolving, and SimuLTE evolves accordingly. We are in fact adding several models to SimuLTE. Among the planned future releases we mention support to device-to-device (D2D) communications and Coordinated Multi-Point transmission (CoMP).

ACKNOWLEDGEMENTS

The authors would like to thank all those who have contributed to the SimuLTE code as former students of the University of Pisa, namely Matteo Maria Andreozzi of NVIDIA, UK, Daniele Migliorini of Aruba, Italy, Giovanni Accongiagioco of CNR, Italy, Generoso Pagano of INRIA Grenoble Rhône-Alpes, France, Vincenzo Maria Pii of ZHAW, Switzerland. They also would like to thank Andras Varga, Rudolf Hornig, Levente Mészáros and Gábor Tabi of Simul-Craft for support and discussion on the code.

REFERENCES

- 3GPP - TS 36.300 Evolved Universal Terrestrial Radio Access (E-UTRA) and Evolved Universal Terrestrial Radio Access Network (E-UTRAN); Overall description; Stage 2
- 3GPP - TS 36.913 Requirements for further advancements for Evolved Universal Terrestrial Radio Access (E-UTRA) (LTE-Advanced)
- Varga, A. and Hornig, R. (2008), "An overview of the OMNeT++ simulation environment", in Proc. SIMU-Tools '08, Marseille, France, March 2008.
- Mehlfuerer, C., Wrulich, M., Ikuno, J.C., Bosanska D., Rupp, M., "Simulating the long term evolution physical layer", in Proc. 17th EUSIPCO, Glasgow, UK, 2009

- Ikuno, J.C., Wrulich, M., Rupp, M., "System level simulation of LTE networks", in Proc. of IEEE VTC-Spring, Taipei, Taiwan, May 2010, pp. 1-5
- Piro, G., Grieco, L. A., Boggia, G., Capozzi F., Camarda, P., "Simulating LTE Cellular Systems: An Open-Source Framework", IEEE Trans. on Vehicular Technology, 60:(2), Feb. 2011
- Ns-3 homepage, available at <http://www.nsnam.org/> [accessed 2014/04]
- Baldo, N., Miozzo, M., Requena-Esteso, M., Nin-Guerrero, J., "An Open Source Product-Oriented LTE Network Simulator based on ns-3", in Proc. of ACM MSWiM'11, Miami, US, Nov. 2011
- Perrone, L. F., Cicconetti, C., Stea, G., Ward, B., "On the Automation of Computer Network Simulators", in Proc. of SIMUTools'09, Rome, Italy, March 3-5, 2009
- 3GPP - TS 36.322 Radio Link Control (RLC) protocol specification
- Weingartner, E., Vom Lehn, H., Wehrle, K., "A performance comparison of recent network simulators", in Proc. of IEEE ICC'09, June 14-18, Dresden, DE, 2009
- 3GPP - TS 36.321 Medium Access Control (MAC) protocol specification
- 3GPP - TS 36.213 Physical layer procedures
- Kurkowski, S., Camp, T., Colagrosso, M., "MANET Simulation Studies: The Incredibles". ACM SIGMOBILE MCCR 9 (4): 50–61, 2005
- Jakes, W.C., Microwave Mobile Communications, Wiley, 1975
- Accongiagioco, G., Andreozzi, M.M., Migliorini, D., Stea, G., "Throughput-optimal Resource Allocation in LTE-Advanced with Distributed Antennas" Computer Networks, vol. 57(2013), pp. 3997-4009
- Fantini, R., Sabella, D., Caretti, M., "An E3F based assessment of Energy Efficiency of Relay Nodes in LTE-Advanced networks", in Proc. IEEE PIMRC 2011, 11-14 Sept. 2011, pp.182-186.
- Perrone, L.F., Main, C., Ward, B.C., "SAFE: Simulation Automation Framework for Experiments", in Proc. of IEEE WSC 2012, Berlin, DE, 9-12 Dec. 2012
- Bouras, C., Diles, G., Kokkinos, V., Kontodimas, K., Papaiozis, A., "A Simulation Framework for Evaluating Interference Mitigation Techniques in Heterogeneous Cellular Environments", Wireless Personal Communications, Springer-Verlag, 2013
- Zhou, D., Baldo, N., Miozzo, M., "Implementation and Validation of LTE Downlink Schedulers for ns-3", in Proc. SIMUTools '13, Cannes, France, March 3013

APPENDIX

Table 2: LTE-related acronyms used in the paper.

Acronym	Definition
AM	Acknowledged RLC mode
BLER	Block Error Rate
BSR	Buffer Status Report
CID	Connection identifier
CoMP	Coordinated Multi-Point
CQI	Channel Quality Indicator
DL	Downlink
DRR	Deficit Round Robin
eNB	Evolved Node-B
EPC	Evolved Packet Core
e-ICIC	Enhanced Inter-Cell Interf. Cancellation
FDD	Frequency Division Duplexing
H-ARQ	Hybrid Automatic Repeat reQuest
LCID	Logical Connection identifier
LTE	Long-term Evolution
LTE-A	Long-term Evolution Advanced
MaxC/I	Maximum Carrier over Interference
PDCCH	Physical Downlink Control CHannel
PDCP	Packet Data Convergence Protocol
PDU	Protocol Data Unit
PF	Proportional Fair
PRACH	Physical Random Access CHannel
RAC	Random Access Procedure
RB	Resource Block
RLC	Radio Link Control
RRC	Radio Resource Control
RU	Remote Unit
SDU	Service Data Unit
SU-MIMO	Single-User MIMO
TM	Transparent RLC mode
TTI	Transmission Time Interval
UE	User Equipment
UL	Uplink
UM	Unacknowledged RLC mode